

KENWOOD

Document Copyrights

Copyright 2006 by Kenwood Corporation. All rights reserved.

No part of this manual may be reproduced, translated, distributed, or transmitted in any form or by any means, electronic, mechanical, photocopying, recording, or otherwise, for any purpose without the prior written permission of Kenwood.

Disclaimer

While every precaution has been taken in the preparation of this manual, Kenwood assumes no responsibility for errors or omissions. Neither is any liability assumed for damages resulting from the use of the information contained herein. Kenwood reserves the right to make changes to any products herein at any time for improvement purposes.

文档版权信息

Kenwood Corporation 拥有版权 2006。保留所有权利。

未经 Kenwood 公司预先书面同意，无论出于何种目的，均不得以任何形式或任何方式包括电子、机械、影印、录音或其他方式复制、翻译、分发或传播本手册的任何部分。

免责声明

Kenwood 公司在准备本文档时已采取所有必要的预防措施，恕不对错误或疏漏承担任何责任，也不对因使用本文中所含的信息而导致的损害负责。Kenwood 公司保留出于改进的需要而随时对文中的产品信息做出更改的权利。

TK-868G

SERVICE MANUAL / 维修手册

SUPPLEMENT / 追补版

KENWOOD

Kenwood Corporation

© 2006-1 PRINTED IN JAPAN
B51-8753-00 (N) PDF

128 channels / 128条信道

C version

This supplement edition service manual provides revisions (schematic, printed board figure, and bill of material) only for the C type of the TK-868G C, C3 version manual (B51-8500-00). Refer to the TK-868G manual (B51-8500-00) for all other details. This is applicable for all models from serial number 70800301 and onwards.

本追补版维修手册仅包含了对C型TK-868G C, C3版手册 (B51-8500-00) 的修订 (印刷板示意图及材料清单)。其他详情请参阅TK-868G手册 (B51-8500-00)。本手册适用于序列号自70800301起的所有型号。

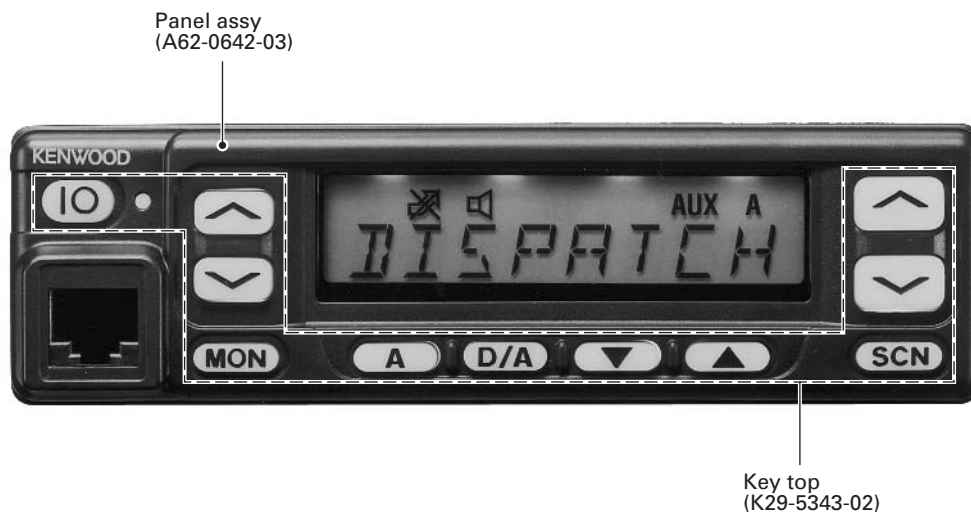

CONTENTS

PARTS LIST	2
PC BOARD	
DISPLAY UNIT (X54-3270-10)	10
PLL/VCO (X58-4670-17)	11
TX-RX UNIT (X57-5963-01) (A/2)	12
TX-RX UNIT (X57-5963-01) (B/2)	16
SCHEMATIC DIAGRAM	18

目 录

零件表	2
PC板	
DISPLAY单元 (X54-3270-10)	10
PLL/VCO (X58-4670-17)	11
TX-RX单元 (X57-5963-01) (A/2)	12
TX-RX单元 (X57-5963-01) (B/2)	16
原理图	18

TK-868G

PARTS LIST / 零件表

* New Parts. Δ indicates safety critical components.

Parts without **Parts No.** are not supplied.

Les articles non mentionnés dans le **Parts No.** ne sont pas fournis.

Teile ohne **Parts No.** werden nicht geliefert.

L : Scandinavia

Y : PX (Far East, Hawaii)

Y : AAFES (Europe)

K : USA

T : England

X : Australia

P : Canada

E : Europe

M : Other Areas

TK-868G (C)

DISPLAY UNIT (X54-3270-10), TX-RX UNIT (X57-5963-01)

Ref. No.	Address	New parts	Parts No.	Description	Destination
TK-868G					
1	1B	*	A01-2165-23	CABINET UPPER	
2	2A	*	A01-2166-23	CABINET LOWER	
3	2A		A62-0642-03	PANEL ASSY	
6	2B		B11-1226-03	ILLUMINATION GUIDE	
7	2A		B38-0824-05	LCD	
8	2D	*	B62-1259-20	INSTRUCTION MANUAL	
9	1C	*	B72-1699-24	MODEL NAME-PLATE	
11	2B		E29-1179-04	INTER CONNECTOR	
12	1C		E30-2145-15	ANTENNA CABLE	
-			E30-3404-05	TRUNK CABLE	
14	1C		E30-7553-05	DC CORD RADIO	
16	1C		E37-0790-25	LEAD WIRE WITH CONNECTOR (SP)	
17	2B		E37-0815-05	FLAT CABLE	
-		*	E37-0852-15	LEAD WIRE WITH CONNECTOR (15P)	
-		*	E37-0853-15	LEAD WIRE WITH CONNECTOR (10P)	
-			E37-0854-15	LEAD WIRE WITH CONNECTOR (8P)	
-			E37-0855-15	LEAD WIRE WITH CONNECTOR (3P)	
18	2B		F12-0435-04	CONDUCTIVE SHEET	
-			F51-0016-15	FUSE (6X30,10A)	
21	1C		G02-0791-04	FLAT SPRING AF, APC	
22	1B,1C		G10-1221-04	FIBROUS SHEET SIDE	
23	1B		G10-1222-14	FIBROUS SHEET UP,DOWN	
24	1A,2C		G10-1223-14	FIBROUS SHEET SHIEL	
25	1C		G13-1468-04	CUSHION DC CORD	
26	1B		G13-1759-04	CUSHION SP	
27	2C		G53-0796-04	PACKING PHONE JACK	
30	2D		H10-6618-12	POLYSTYRENE FOAMED FIXTURE (F)	
31	1E		H10-6619-12	POLYSTYRENE FOAMED FIXTURE (R)	
33	2E		H25-0720-04	PROTECTION BAG (200X350)	
34	3E		H52-1520-02	ITEM CARTON CASE	
37	2A		J21-8382-03	HARDWARE FIXTURE	
40	2A		K29-5343-02	KEY TOP	
A	2A,1B		N33-2606-45	OVAL HEAD MACHINE SCREW	
B	2C		N67-3008-46	PAN HEAD SEMS SCREW	
C	2B,1C		N87-2606-46	BRAZIER HEAD TAPTITE SCREW	
D	2B		N87-2612-46	BRAZIER HEAD TAPTITE SCREW	
44	1B		T07-0368-15	SPEAKER	
DISPLAY UNIT (X54-3270-10)					
D802-805		*	B30-2220-05	LED (2P/YELLOW)	
C801-803			CC73GCH1H101J	CHIP C 100PF J	
C804			CK73GF1A105Z	CHIP C 1.0UF Z	
C805			CK73GB1H102K	CHIP C 1000PF K	
C806,807			CK73GB1H471K	CHIP C 470PF K	
CN801			E40-6020-05	PIN ASSY	
L801			L92-0138-05	FERRITE CHIP	

Ref. No.	Address	New parts	Parts No.	Description	Destination
R801-803			RK73GB2A103J	CHIP R 10K J 1/10W	
R804			RK73GB2A473J	CHIP R 47K J 1/10W	
R805			RK73GB2A474J	CHIP R 470K J 1/10W	
R806			RK73GB2A000J	CHIP R 0.0 J 1/10W	
R808			RK73GB2A392J	CHIP R 3.9K J 1/10W	
R809			RK73FB2B270J	CHIP R 27 J 1/8W	
D801			MA2S111	DIODE	
D808			DA204U	DIODE	
IC801			LC75823W	MOS-IC	
Q801			2SB1132(Q,R)	TRANSISTOR	
TX-RX UNIT (X57-5963-01)					
D509-514			B30-2050-05	LED	
D521			B30-2151-05	LED (RED/GRN)	
C1-11			CK73GB1H471K	CHIP C 470PF K	
C13-19			CK73GB1H471K	CHIP C 470PF K	
C20			C92-0507-05	CHIP-TAN 4.7UF 6.3WV	
C21			CK73GB1H471K	CHIP C 470PF K	
C22			CK73GB1C104K	CHIP C 0.10UF K	
C23,24			C92-0507-05	CHIP-TAN 4.7UF 6.3WV	
C25			CC73GCH1H060D	CHIP C 6.0PF D	
C26			CK73GB1H471K	CHIP C 470PF K	
C28			CC73GCH1H060D	CHIP C 6.0PF D	
C29			C92-0507-05	CHIP-TAN 4.7UF 6.3WV	
C30			CC73GCH1H020B	CHIP C 2.0PF B	
C31			CK73GB1H102K	CHIP C 1000PF K	
C32			C92-0662-05	CHIP-TAN 15UF 6.3WV	
C33			CC73GCH1H220J	CHIP C 22PF J	
C34			CK73GB1A105K	CHIP C 1.0UF K	
C35			CK73GB1C104K	CHIP C 0.10UF K	
C36			CK73GB1H102K	CHIP C 1000PF K	
C37			CK73FB1C334K	CHIP C 0.33UF K	
C39			CK73GB1C104K	CHIP C 0.10UF K	
C40			CK73GB1H102K	CHIP C 1000PF K	
C41			CK73GB1H103K	CHIP C 0.010UF K	
C43			C92-0507-05	CHIP-TAN 4.7UF 6.3WV	
C44			CK73GB1H331K	CHIP C 330PF K	
C45			CC73GCH1H470J	CHIP C 47PF J	
C46			CK73GB1H103K	CHIP C 0.010UF K	
C47			C92-0561-05	CHIP-ELE 22UF 16WV	
C49			CK73GB1H102K	CHIP C 1000PF K	
C51			CK73GB1C104K	CHIP C 0.10UF K	
C52			CC73GCH1H680J	CHIP C 68PF J	
C53			CK73GB1C104K	CHIP C 0.10UF K	
C54			CK73GB1H103K	CHIP C 0.010UF K	
C55			CC73GCH1H010B	CHIP C 1.0PF B	
C56			CC73GCH1H220J	CHIP C 22PF J	
C58			CK73GB1E223K	CHIP C 0.022UF K	
C60			CK73GB1H102K	CHIP C 1000PF K	
C61			CC73GCH1H050C	CHIP C 5.0PF C	
C62			CC73GCH1H101J	CHIP C 100PF J	
C63			CK73GB1C104K	CHIP C 0.10UF K	
C64			CK73GB1H103K	CHIP C 0.010UF K	
C66			CK73GB1H102K	CHIP C 1000PF K	

PARTS LIST / 零件表

TX-RX UNIT (X57-5963-01)

Ref. No.	Address	New parts	Parts No.	Description	Desti-nation	Ref. No.	Address	New parts	Parts No.	Description	Desti-nation
C67			CK73GB1A105K	CHIP C 1.0UF K		C142			CC73GCH1H010C	CHIP C 1.0PF C	
C68			CC73GCH1H101J	CHIP C 100PF J		C143			CK73GB1H471K	CHIP C 470PF K	
C69			CK73GB1C104K	CHIP C 0.10UF K		C144			CK73GB1H102K	CHIP C 1000PF K	
C70			C92-0507-05	CHIP-TAN 4.7UF 6.3WV		C145			CC73GCH1H050C	CHIP C 5.0PF C	
C71			CC73GCH1H101J	CHIP C 100PF J		C146			CK73GB1H471K	CHIP C 470PF K	
C72			C92-0507-05	CHIP-TAN 4.7UF 6.3WV		C148,149			CK73GB1H471K	CHIP C 470PF K	
C73			CC73GCH1H101J	CHIP C 100PF J		C150			CK73FF1C105Z	CHIP C 1.0UF Z	
C74,75			CK73GB1H471K	CHIP C 470PF K		C152			CC73GCH1H060D	CHIP C 6.0PF D	
C77			C92-0610-05	ELECTRO 47UF 16WV		C153			CC73GCH1H040C	CHIP C 4.0PF C	
C78			CK73GB1C104K	CHIP C 0.10UF K		C154			CK73GB1H102K	CHIP C 1000PF K	
C79,80			CK73GB1H102K	CHIP C 1000PF K		C155			CC73GCH1H060D	CHIP C 6.0PF D	
C81			CK73GB1H471K	CHIP C 470PF K		C156			CK73GB1H471K	CHIP C 470PF K	
C82			C92-0507-05	CHIP-TAN 4.7UF 6.3WV		C157			CK73GB1H102K	CHIP C 1000PF K	
C83			CC73GCH1H270J	CHIP C 27PF J		C158			CK73GB1H471K	CHIP C 470PF K	
C84			C92-0507-05	CHIP-TAN 4.7UF 6.3WV		C160,161			C92-0719-05	ELECTRO 47UF 25WV	
C86			C92-0662-05	CHIP-TAN 15UF 6.3WV		C162,163			CK73GB1H471K	CHIP C 470PF K	
C87			CC73GCH1H330J	CHIP C 33PF J		C164			CK73GB1H102K	CHIP C 1000PF K	
C88			CK73GB1H103K	CHIP C 0.010UF K		C165			C92-0719-05	ELECTRO 47UF 25WV	
C89			CK73GB1H471K	CHIP C 470PF K		C166			CE04EW1E471M	ELECTRO 470UF 25WV	
C91			CC73GCH1H020B	CHIP C 2.0PF B		C167			CK73GB1H471K	CHIP C 470PF K	
C93			C92-0555-05	CHIP-TAN 0.047UF 35WV		C168			CC73GCH1H060D	CHIP C 6.0PF D	
C95,96			CK73GB1H471K	CHIP C 470PF K		C169			CK73GB1H471K	CHIP C 470PF K	
C97			C92-0546-05	CHIP-TAN 68UF 6.3WV		C172			CE04EW1E471M	ELECTRO 470UF 25WV	
C98			CK73GB1H103K	CHIP C 0.010UF K		C173			CK73GB1C104K	CHIP C 0.10UF K	
C99			C92-0008-05	CHIP-TAN 3.3UF 16WV		C174			CK73GB1H471K	CHIP C 470PF K	
C100			CC73GCH1H020B	CHIP C 2.0PF B		C177			CC73FCH1H220J	CHIP C 22PF J	
C101			CK73GB1H471K	CHIP C 470PF K		C178			CC73GCH1H060D	CHIP C 6.0PF D	
C102			CC73GCH1H020B	CHIP C 2.0PF B		C179			CK73GB1H471K	CHIP C 470PF K	
C103			CK73GB1H471K	CHIP C 470PF K		C181,182			CK73GB1H471K	CHIP C 470PF K	
C104			C92-0555-05	CHIP-TAN 0.047UF 35WV		C183			CK73GB1C104K	CHIP C 0.10UF K	
C105			CC73GCH1H100D	CHIP C 10PF D		C185			CK73GB1C104K	CHIP C 0.10UF K	
C106			CC73GCH1H180J	CHIP C 18PF J		C186			CK73GB1H471K	CHIP C 470PF K	
C107			CK73GB1H471K	CHIP C 470PF K		C187			CC73GCH1H060D	CHIP C 6.0PF D	
C108			CC73GCH1H050B	CHIP C 5.0PF B		C189			CC73FCH1H040C	CHIP C 4.0PF C	
C109			CK73GB1H471K	CHIP C 470PF K		C190			CK73GB1H471K	CHIP C 470PF K	
C111			CC73GCH1H030C	CHIP C 3.0PF C		C192			CK73GB1H103K	CHIP C 0.010UF K	
C112			CK73GB1H471K	CHIP C 470PF K		C196			CK73GB1H471K	CHIP C 470PF K	
C113			C92-0507-05	CHIP-TAN 4.7UF 6.3WV		C198			C92-0719-05	ELECTRO 47UF 25WV	
C114			C92-0697-05	CHIP-TAN 3.3UF 16WV		C199		*	CK73GB1E154K	CHIP C 0.15UF K	
C115			C92-0001-05	CHIP-TAN 0.1UF 35WV		C201			CK73GB1H471K	CHIP C 470PF K	
C116			CK73GB1H103K	CHIP C 0.010UF K		C202			CK73GB1C104K	CHIP C 0.10UF K	
C117			CK73GB1H102K	CHIP C 1000PF K		C203			CK73GB1H471K	CHIP C 470PF K	
C118			CC73GCH1H040C	CHIP C 4.0PF C		C204			C92-0004-05	CHIP-TAN 1.0UF 16WV	
C119			CK73GB1H103K	CHIP C 0.010UF K		C206			CK73GB1H102K	CHIP C 1000PF K	
C120			CC73GCH1H040C	CHIP C 4.0PF C		C207			CK73GB1H103K	CHIP C 0.010UF K	
C121			CK73GB1H471K	CHIP C 470PF K		C208			CC73GCH1H050C	CHIP C 5.0PF C	
C122,123			CK73GB1C104K	CHIP C 0.10UF K		C209			CC73FCH1H050C	CHIP C 5.0PF C	
C125			C92-0005-05	CHIP-TAN 2.2UF 6.3WV		C210			CK73GB1H103K	CHIP C 0.010UF K	
C126			CC73GCH1H120J	CHIP C 12PF J		C211			CC73GCH1H180J	CHIP C 18PF J	
C127			CK73GB1H103K	CHIP C 0.010UF K		C212			CK73GB1H471K	CHIP C 470PF K	
C128			C92-0543-05	CHIP-TAN 3.3UF 10WV		C213			C93-0550-05	CHIP C 1.0PF C	
C129			CK73FF1C105Z	CHIP C 1.0UF Z		C215			CC73FCH1H060D	CHIP C 6.0PF D	
C130			CK73GB1H103K	CHIP C 0.010UF K		C216			CC73GCH1HOR5B	CHIP C 0.5PF B	
C131			CK73GB1H102K	CHIP C 1000PF K		C217			CC73GCH1H020B	CHIP C 2.0PF B	
C133			CK73GB1H471K	CHIP C 470PF K		C218			CK73GB1C104K	CHIP C 0.10UF K	
C134			CK73FB1E104K	CHIP C 0.10UF K		C219			CC73FCH1H040C	CHIP C 4.0PF C	
C135			CC73GCH1H180J	CHIP C 18PF J		C220			CK73GB1H471K	CHIP C 470PF K	
C138			CK73FB1E104K	CHIP C 0.10UF K		C221			C93-0550-05	CHIP C 1.0PF C	
C139,140			CK73GB1H471K	CHIP C 470PF K		C222			CC73GCH1HOR5B	CHIP C 0.5PF B	
C141			C92-0719-05	ELECTRO 47UF 25WV		C223			CC73GCH1H020B	CHIP C 2.0PF B	

PARTS LIST / 零件表

TX-RX UNIT (X57-5963-01)

Ref. No.	Address	New parts	Parts No.	Description	Destination	Ref. No.	Address	New parts	Parts No.	Description	Destination
C224			CK73GB1H471K	CHIP C 470PF K		C553			CK73GB1H102K	CHIP C 1000PF K	
C225			C93-0603-05	CHIP C 1000PF K		C554			CK73GB1H122K	CHIP C 1200PF K	
C226			C93-0556-05	CHIP C 6.0PF D		C555			C92-0560-05	CHIP-TAN 10UF 6.3WV	
C227			C93-0558-05	CHIP C 8.0PF D		C556			CK73GB1C333K	CHIP C 0.033UF K	
C229			C93-0556-05	CHIP C 6.0PF D		C557			CK73GB1C104K	CHIP C 0.10UF K	
C230,231			CK73GB1C104K	CHIP C 0.10UF K		C558			CC73GCH1H101J	CHIP C 100PF J	
C241			CK73GB1H471K	CHIP C 470PF K		C559			CK73GB1H102K	CHIP C 1000PF K	
C248			C92-0585-05	CHIP-TAN 4.7UF 16WV		C560-563			CK73GB1C104K	CHIP C 0.10UF K	
C251			CK73GB1H221K	CHIP C 220PF K		C564			C92-0507-05	CHIP-TAN 4.7UF 6.3WV	
C254			CK73GB1C104K	CHIP C 0.10UF K		C565,566			CK73GB1H472K	CHIP C 4700PF K	
C257			CK73GB1C104K	CHIP C 0.10UF K		C567			CC73GCH1H101J	CHIP C 100PF J	
C259			CK73GB1C104K	CHIP C 0.10UF K		C568			C92-0507-05	CHIP-TAN 4.7UF 6.3WV	
C265			CK73GB1H471K	CHIP C 470PF K		C569			CK73GB1E223K	CHIP C 0.022UF K	
C266			CK73GB1A105K	CHIP C 1.0UF K		C570			CK73FF1C105Z	CHIP C 1.0UF Z	
C270			CK73GB1H471K	CHIP C 470PF K		C571,572			CK73GB1H102K	CHIP C 1000PF K	
C271			CK73GB1H681K	CHIP C 680PF K		C573			CK73FB1H563K	CHIP C 0.056UF K	
C275			CK73GB1H471K	CHIP C 470PF K		C574			CC73GCH1H470J	CHIP C 47PF J	
C278			CK73GB1H221K	CHIP C 220PF K		C575			CK73GB1H102K	CHIP C 1000PF K	
C285			CK73GB1H221K	CHIP C 220PF K		C576			CK73GB1C104K	CHIP C 0.10UF K	
C292-294			CK73GB1H471K	CHIP C 470PF K		C577,578			CK73GB1H103K	CHIP C 0.010UF K	
C298			CC73GCH1H680J	CHIP C 68PF J		C579			CC73GCH1H101J	CHIP C 100PF J	
C299			CK73GB1H471K	CHIP C 470PF K		C580			CK73GB1C104K	CHIP C 0.10UF K	
C300			CK73GB1A105K	CHIP C 1.0UF K		C581			CK73GB1H102K	CHIP C 1000PF K	
C501			CK73GB1H102K	CHIP C 1000PF K		C582			CK73GB1C473K	CHIP C 0.047UF K	
C502			CK73GB1C104K	CHIP C 0.10UF K		C583			C92-0560-05	CHIP-TAN 10UF 6.3WV	
C503			CK73GB1H471K	CHIP C 470PF K		C584			CK73GB1H103K	CHIP C 0.010UF K	
C504			CK73GB1H103K	CHIP C 0.010UF K		C585			CC73GCH1H101J	CHIP C 100PF J	
C505			CK73GB1C104K	CHIP C 0.10UF K		C587			CK73GB1H103K	CHIP C 0.010UF K	
C506,507			CK73GB1H103K	CHIP C 0.010UF K		C589			C92-0606-05	CHIP-TAN 4.7UF 10WV	
C508			CK73GB1H472K	CHIP C 4700PF K		C590			CK73GB1H102K	CHIP C 1000PF K	
C509			C92-0507-05	CHIP-TAN 4.7UF 6.3WV		C594			CK73GB1H102K	CHIP C 1000PF K	
C514			CC73GCH1H680J	CHIP C 68PF J		C596			CK73GB1H102K	CHIP C 1000PF K	
C515			CK73HB1E103K	CHIP C 0.010UF K		C597			CC73GCH1H101J	CHIP C 100PF J	
C516			CC73GCH1H300J	CHIP C 30PF J		C598			CK73GB1H102K	CHIP C 1000PF K	
C517			CK73GB1E153K	CHIP C 0.015UF K		C599			CC73GCH1H101J	CHIP C 100PF J	
C518			CC73GCH1H300J	CHIP C 30PF J		C600			CK73GB1H102K	CHIP C 1000PF K	
C519			CK73GB1H102K	CHIP C 1000PF K		C601,602			CC73GCH1H101J	CHIP C 100PF J	
C520			CK73GB1C104K	CHIP C 0.10UF K		C603			CK73GB1H102K	CHIP C 1000PF K	
C521			CK73GB1H102K	CHIP C 1000PF K		C604-606			CC73GCH1H101J	CHIP C 100PF J	
C522			C92-0507-05	CHIP-TAN 4.7UF 6.3WV		C608-610			CC73GCH1H101J	CHIP C 100PF J	
C523			CC73GCH1H121J	CHIP C 120PF J		C611,612			CK73GB1H471K	CHIP C 470PF K	
C524			CK73GB1H103K	CHIP C 0.010UF K		C613			CC73GCH1H101J	CHIP C 100PF J	
C525			CK73GB1E123K	CHIP C 0.012UF K		C615			CK73GB1H471K	CHIP C 470PF K	
C526			CK73GB1C683K	CHIP C 0.068UF K		C616			CC73GCH1H101J	CHIP C 100PF J	
C527			CK73GB1H222K	CHIP C 2200PF K		C618			CK73GB1H102K	CHIP C 1000PF K	
C528			CK73GB1H103K	CHIP C 0.010UF K		C620			CK73GB1H471K	CHIP C 470PF K	
C529			CK73GB1H272K	CHIP C 2700PF K		C621			CK73GB1H102K	CHIP C 1000PF K	
C530			CK73GB1H152K	CHIP C 1500PF K		C623			CK73GB1H102K	CHIP C 1000PF K	
C531			CK73GB1H272K	CHIP C 2700PF K		C626			CK73GB1C104K	CHIP C 0.10UF K	
C532,533			CK73GB1C104K	CHIP C 0.10UF K		C628			CK73GB1C104K	CHIP C 0.10UF K	
C534,535			CK73GB1H103K	CHIP C 0.010UF K		C629			CC73GCH1H470J	CHIP C 47PF J	
C536,537			CK73GB1C104K	CHIP C 0.10UF K		C630			C92-0507-05	CHIP-TAN 4.7UF 6.3WV	
C538			C92-0560-05	CHIP-TAN 10UF 6.3WV		C631			CK73GB1H103K	CHIP C 0.010UF K	
C539			CK73GB1H103K	CHIP C 0.010UF K		C632			CK73FF1C105Z	CHIP C 1.0UF Z	
C540,541			CK73GB1C104K	CHIP C 0.10UF K		C633			CK73GB1C104K	CHIP C 0.10UF K	
C542			CC73GCH1H331J	CHIP C 330PF J		C720			C92-0560-05	CHIP-TAN 10UF 6.3WV	
C543			CK73GB1H102K	CHIP C 1000PF K		CN1			E40-6047-05	PIN ASSY	
C544-546			CK73GB1H562K	CHIP C 5600PF K		CN2			E40-6021-05	FLAT CABLE CONNECTOR	
C548-550			CK73GB1H272K	CHIP C 2700PF K		CN3			E40-3247-05	PIN ASSY	
C551			CC73GCH1H151J	CHIP C 150PF J							

PARTS LIST / 零件表

TX-RX UNIT (X57-5963-01)

Ref. No.	Address	New parts	Parts No.	Description	Destination	Ref. No.	Address	New parts	Parts No.	Description	Destination
CN4			E40-5737-05	PIN ASSY		R9,10			RK73GB2A000J	CHIP R 0.0 J 1/10W	
CN5			E40-5738-05	PIN ASSY		R11			RK73GB2A102J	CHIP R 1.0K J 1/10W	
CN6			E40-5751-05	PIN ASSY		R12			RK73GB2A104J	CHIP R 100K J 1/10W	
CN7			E40-3247-05	PIN ASSY		R13			RK73GB2A472J	CHIP R 4.7K J 1/10W	
CN8			E40-3246-05	PIN ASSY		R14			RK73GB2A474J	CHIP R 470K J 1/10W	
CN501			E40-6021-05	FLAT CABLE CONNECTOR		R15			RK73GB2A104J	CHIP R 100K J 1/10W	
J1			E11-0442-05	3.5D PHONE JACK (3P)		R16			RK73GB2A220J	CHIP R 22 J 1/10W	
J501			E08-0877-05	MODULAR JACK		R17			RK73GB2A154J	CHIP R 150K J 1/10W	
F1			F53-0108-05	FUSE (1.8A 50V)		R18			RK73GB2A103J	CHIP R 10K J 1/10W	
-			J31-0543-05	COLLAR (LH-5-1.5)		R19			RK73GB2A392J	CHIP R 3.9K J 1/10W	
CF1			L72-0999-05	CERAMIC FILTER		R20			RK73GB2A124J	CHIP R 120K J 1/10W	
CF2			L72-0993-05	CERAMIC FILTER		R21			RK73GB2A102J	CHIP R 1.0K J 1/10W	
L1			L41-1005-33	SMALL FIXED INDUCTOR (10UH)		R22			RK73GB2A474J	CHIP R 470K J 1/10W	
L2-4			L40-3381-86	SMALL FIXED INDUCTOR (0.33UH)		R23			RK73GB2A223J	CHIP R 22K J 1/10W	
L5			L34-4725-05	COIL		R24			RK73GB2A103J	CHIP R 10K J 1/10W	
L6			L40-3975-77	SMALL FIXED INDUCTOR (39NH)		R25			RK73GB2A000J	CHIP R 0.0 J 1/10W	
L7			L40-5685-85	SMALL FIXED INDUCTOR (0.56UH)		R26			RK73GB2A104J	CHIP R 100K J 1/10W	
L8			L40-8285-85	SMALL FIXED INDUCTOR (0.82UH)		R29			RK73GB2A000J	CHIP R 0.0 J 1/10W	
L9			L40-1275-77	SMALL FIXED INDUCTOR (12NH)		R30			RK73GB2A103J	CHIP R 10K J 1/10W	
L10			L40-2275-77	SMALL FIXED INDUCTOR (22NH)		R31			RK73GB2A152J	CHIP R 1.5K J 1/10W	
L11		*	L41-1075-33	SMALL FIXED INDUCTOR (0.01UH)		R32			RK73GB2A103J	CHIP R 10K J 1/10W	
L13			L79-1585-05	HELICAL BLOCK		R33			RK73GB2A000J	CHIP R 0.0 J 1/10W	
L14			L40-1875-77	SMALL FIXED INDUCTOR (18NH)		R34			RK73GB2A104J	CHIP R 100K J 1/10W	
L15			L40-6875-77	SMALL FIXED INDUCTOR (68NH)		R35			RK73GB2A224J	CHIP R 220K J 1/10W	
L16		*	L41-3375-33	SMALL FIXED INDUCTOR (0.033UH)		R36			RK73GB2A223J	CHIP R 22K J 1/10W	
L17			L40-1875-77	SMALL FIXED INDUCTOR (18NH)		R37			RK73GB2A000J	CHIP R 0.0 J 1/10W	
L18		*	L41-1875-33	SMALL FIXED INDUCTOR (0.018UH)		R38-40			RK73GB2A103J	CHIP R 10K J 1/10W	
L19			L40-3375-77	SMALL FIXED INDUCTOR (33NH)		R41			RK73GB2A224J	CHIP R 220K J 1/10W	
L20			L40-1875-77	SMALL FIXED INDUCTOR (18NH)		R42			RK73GB2A473J	CHIP R 47K J 1/10W	
L21			L34-4478-05	AIR-CORE COIL		R43			RK73GB2A683J	CHIP R 68K J 1/10W	
L22			L79-1585-05	HELICAL BLOCK		R44			RK73GB2A153J	CHIP R 15K J 1/10W	
L26		*	L41-3375-33	SMALL FIXED INDUCTOR (0.033UH)		R46			RK73GB2A223J	CHIP R 22K J 1/10W	
L27		*	L41-1575-33	SMALL FIXED INDUCTOR (0.015UH)		R47			RK73GB2A101J	CHIP R 100 J 1/10W	
L29			L34-1185-05	AIR-CORE COIL		R48			RK73GB2A474J	CHIP R 470K J 1/10W	
L30,31			L34-1039-05	AIR-CORE COIL		R49			RK73GB2A152J	CHIP R 1.5K J 1/10W	
L32			L34-4478-05	AIR-CORE COIL		R50			RK73GB2A104J	CHIP R 100K J 1/10W	
L33,34			L92-0179-05	CHIP FERRITE		R51-53			RK73GB2A102J	CHIP R 1.0K J 1/10W	
L38,39			L40-1075-77	SMALL FIXED INDUCTOR (10NH)		R54			RK73GB2A000J	CHIP R 0.0 J 1/10W	
L501			L92-0138-05	CHIP FERRITE		R56			RK73GB2A100J	CHIP R 10 J 1/10W	
L503,504			L92-0138-05	CHIP FERRITE		R57			RK73GB2A471J	CHIP R 470 J 1/10W	
L510			L92-0138-05	CHIP FERRITE		R58			RK73GB2A682J	CHIP R 6.8K J 1/10W	
X1		*	L77-1992-05	TCXO (16.8MHZ)		R59			RK73GB2A472J	CHIP R 4.7K J 1/10W	
X501			L78-0479-05	RESONATOR (3.58MHZ)		R60			RK73GB2A154J	CHIP R 150K J 1/10W	
X502			L78-1418-05	RESONATOR (9.8304M)		R61			RK73GB2A221J	CHIP R 220 J 1/10W	
XF1			L71-0551-45	MCF (49.95MHZ/5.0KHZ)		R62			RK73GB2A224J	CHIP R 220K J 1/10W	
CP501-505			R90-0741-05	MULTIPLE RESISTOR		R63			RK73GB2A154J	CHIP R 150K J 1/10W	
CP508-514			R90-0741-05	MULTIPLE RESISTOR		R64			RK73GB2A682J	CHIP R 6.8K J 1/10W	
CP516-524			R90-0741-05	MULTIPLE RESISTOR		R65			RK73GB2A103J	CHIP R 10K J 1/10W	
CP526,527			R90-0741-05	MULTIPLE RESISTOR		R66			RK73GB2A101J	CHIP R 100 J 1/10W	
CP529-536			R90-0741-05	MULTIPLE RESISTOR		R67			RK73GB2A222J	CHIP R 2.2K J 1/10W	
CP538			R90-0741-05	MULTIPLE RESISTOR		R68			RK73GB2A221J	CHIP R 220 J 1/10W	
CP539			RK75GB1J102J	CHIP-COM 1.0K J 1/16W		R69			RK73GB2A000J	CHIP R 0.0 J 1/10W	
R1			RK73GB2A000J	CHIP R 0.0 J 1/10W		R70			RK73GB2A183J	CHIP R 18K J 1/10W	
R2			RK73GB2A102J	CHIP R 1.0K J 1/10W		R71			RK73GB2A682J	CHIP R 6.8K J 1/10W	
R3			RK73GB2A000J	CHIP R 0.0 J 1/10W		R72			RK73GB2A000J	CHIP R 0.0 J 1/10W	
R4			RK73GB2A154J	CHIP R 150K J 1/10W		R75			RK73GB2A000J	CHIP R 0.0 J 1/10W	
R6			RK73GB2A000J	CHIP R 0.0 J 1/10W		R76			RK73GB2A223J	CHIP R 22K J 1/10W	
R7,8			RK73GB2A102J	CHIP R 1.0K J 1/10W		R77			RK73GB2A224J	CHIP R 220K J 1/10W	
						R78			RK73GB2A124J	CHIP R 120K J 1/10W	
						R79			RK73GB2A102J	CHIP R 1.0K J 1/10W	

PARTS LIST / 零件表

TX-RX UNIT (X57-5963-01)

Ref. No.	Address	New parts	Parts No.	Description	Destination	Ref. No.	Address	New parts	Parts No.	Description	Destination
R80			RK73GB2A471J	CHIP R 470 J 1/10W		R158			RK73FB2B221J	CHIP R 220 J 1/8W	
R81			RK73GB2A101J	CHIP R 100 J 1/10W		R159			RK73GB2A473J	CHIP R 47K J 1/10W	
R82			RK73GB2A000J	CHIP R 0.0 J 1/10W		R160			RK73FB2B331J	CHIP R 330 J 1/8W	
R83			RK73GB2A684J	CHIP R 680K J 1/10W		R161,162			RK73GB2A104J	CHIP R 100K J 1/10W	
R84			RK73GB2A000J	CHIP R 0.0 J 1/10W		R163			RK73FB2B000J	CHIP R 0.0 J 1/8W	
R86			RK73GB2A122J	CHIP R 1.2K J 1/10W		R166			RK73GB2A151J	CHIP R 150 J 1/10W	
R87			RK73GB2A102J	CHIP R 1.0K J 1/10W		R172			RK73GB2A474J	CHIP R 470K J 1/10W	
R88			RK73GB2A271J	CHIP R 270 J 1/10W		R173			RK73GB2A472J	CHIP R 4.7K J 1/10W	
R89			RK73GB2A102J	CHIP R 1.0K J 1/10W		R174			RK73GB2A103J	CHIP R 10K J 1/10W	
R90			RK73GB2A104J	CHIP R 100K J 1/10W		R175			RK73GB2A682J	CHIP R 6.8K J 1/10W	
R91			RK73GB2A823J	CHIP R 82K J 1/10W		R176			RK73GB2A103J	CHIP R 10K J 1/10W	
R92			RK73GB2A822J	CHIP R 8.2K J 1/10W		R177			RK73RB2H151J	CHIP R 150 J 1/2W	
R93			RK73GB2A102J	CHIP R 1.0K J 1/10W		R178			RK73GB2A822J	CHIP R 8.2K J 1/10W	
R94			RK73GB2A392J	CHIP R 3.9K J 1/10W		R179			RK73GB2A223J	CHIP R 22K J 1/10W	
R95,96			RK73GB2A103J	CHIP R 10K J 1/10W		R180,181			RK73GB2A562J	CHIP R 5.6K J 1/10W	
R97,98			RK73GB2A101J	CHIP R 100 J 1/10W		R182			RK73FB2B000J	CHIP R 0.0 J 1/8W	
R99			RK73GB2A271J	CHIP R 270 J 1/10W		R184			RK73GB2A000J	CHIP R 0.0 J 1/10W	
R100,101			RK73GB2A222J	CHIP R 2.2K J 1/10W		R185			RK73GB2A473J	CHIP R 47K J 1/10W	
R103			RK73GB2A472J	CHIP R 4.7K J 1/10W		R186			RK73GB2A000J	CHIP R 0.0 J 1/10W	
R104			RK73GB2A332J	CHIP R 3.3K J 1/10W		R187			RK73GB2A101J	CHIP R 100 J 1/10W	
R105			RK73GB2A101J	CHIP R 100 J 1/10W		R188			RK73GB2A102J	CHIP R 1.0K J 1/10W	
R106			RK73GB2A102J	CHIP R 1.0K J 1/10W		R189			RK73GB2A101J	CHIP R 100 J 1/10W	
R107			RK73GB2A473J	CHIP R 47K J 1/10W		R190			RK73GB2A473J	CHIP R 47K J 1/10W	
R108			RK73GB2A331J	CHIP R 330 J 1/10W		R192			RK73GB2A103J	CHIP R 10K J 1/10W	
R109			RK73GB2A103J	CHIP R 10K J 1/10W		R193			RK73GB2A104J	CHIP R 100K J 1/10W	
R110			RK73GB2A470J	CHIP R 47 J 1/10W		R196			RK73GB2A332J	CHIP R 3.3K J 1/10W	
R111			RK73GB2A101J	CHIP R 100 J 1/10W		R197			RK73GB2A000J	CHIP R 0.0 J 1/10W	
R112			RK73GB2A331J	CHIP R 330 J 1/10W		R198			RK73GB2A104J	CHIP R 100K J 1/10W	
R113			RK73GB2A332J	CHIP R 3.3K J 1/10W		R199-202			RK73GB2A000J	CHIP R 0.0 J 1/10W	
R114			RK73GB2A472J	CHIP R 4.7K J 1/10W		R207			RK73GB2A330J	CHIP R 33 J 1/10W	
R115			RK73GB2A563J	CHIP R 56K J 1/10W		R208			RK73GB2A100J	CHIP R 10 J 1/10W	
R116			RK73GB2A473J	CHIP R 47K J 1/10W		R210			RK73GB2A332J	CHIP R 3.3K J 1/10W	
R118			RK73GB2A681J	CHIP R 680 J 1/10W		R219			RK73GB2A000J	CHIP R 0.0 J 1/10W	
R120			RK73GB2A000J	CHIP R 0.0 J 1/10W		R221			RK73GB2A000J	CHIP R 0.0 J 1/10W	
R122			RK73RB2H471J	CHIP R 470 J 1/2W		R232			RK73GB2A000J	CHIP R 0.0 J 1/10W	
R123			RK73GB2A472J	CHIP R 4.7K J 1/10W		R233			RK73GB2A333J	CHIP R 33K J 1/10W	
R124			RK73GB2A103J	CHIP R 10K J 1/10W		R234,235			RK73GB2A104J	CHIP R 100K J 1/10W	
R125			RK73GB2A333J	CHIP R 33K J 1/10W		R236			RK73GB2A823J	CHIP R 82K J 1/10W	
R126			RK73GB2A471J	CHIP R 470 J 1/10W		R237			RK73GB2A104J	CHIP R 100K J 1/10W	
R127,128			RK73GB2A104J	CHIP R 100K J 1/10W		R242			RK73GB2A393J	CHIP R 39K J 1/10W	
R129			RK73GB2A331J	CHIP R 330 J 1/10W		R243			RK73GB2A000J	CHIP R 0.0 J 1/10W	
R130			RK73GB2A102J	CHIP R 1.0K J 1/10W		R501			RK73GB2A473J	CHIP R 47K J 1/10W	
R131			RK73GB2A681J	CHIP R 680 J 1/10W		R502			RK73GB2A472J	CHIP R 4.7K J 1/10W	
R132			RK73FB2B000J	CHIP R 0.0 J 1/8W		R503			RK73GB2A102J	CHIP R 1.0K J 1/10W	
R133-136			RK73GB2A000J	CHIP R 0.0 J 1/10W		R504-507			RK73GB2A473J	CHIP R 47K J 1/10W	
R138			RK73GB2A102J	CHIP R 1.0K J 1/10W		R508-510			RK73GB2A000J	CHIP R 0.0 J 1/10W	
R140			RK73FB2B2R2J	CHIP R 2.2 J 1/8W		R511			RK73GB2A473J	CHIP R 47K J 1/10W	
R141			RK73RB2H220J	CHIP R 22 J 1/2W		R512			RK73GB2A104J	CHIP R 100K J 1/10W	
R142			RK73GB2A473J	CHIP R 47K J 1/10W		R513			RK73GB2A683J	CHIP R 68K J 1/10W	
R143			RK73GB2A101J	CHIP R 100 J 1/10W		R514			RK73GB2A473J	CHIP R 47K J 1/10W	
R145,146			RK73GB2A473J	CHIP R 47K J 1/10W		R515,516			RK73GB2A153J	CHIP R 15K J 1/10W	
R147,148			RK73GB2A104J	CHIP R 100K J 1/10W		R517			RK73GB2A473J	CHIP R 47K J 1/10W	
R149			RK73GB2A151J	CHIP R 150 J 1/10W		R518			RK73GB2A472J	CHIP R 4.7K J 1/10W	
R150			RK73GB2A104J	CHIP R 100K J 1/10W		R519			RK73GB2A103J	CHIP R 10K J 1/10W	
R151			RK73FB2B331J	CHIP R 330 J 1/8W		R520-523			RK73GB2A102J	CHIP R 1.0K J 1/10W	
R152			RK73GB2A000J	CHIP R 0.0 J 1/10W		R526			RK73GB2A154J	CHIP R 150K J 1/10W	
R153			RK73FB2B000J	CHIP R 0.0 J 1/8W		R527			RK73GB2A000J	CHIP R 0.0 J 1/10W	
R154			RK73GB2A152J	CHIP R 1.5K J 1/10W		R528			RK73HB1J472J	CHIP R 4.7K J 1/16W	
R155			RK73GB2A104J	CHIP R 100K J 1/10W		R529			RK73GB2A154J	CHIP R 150K J 1/10W	
R156			RK73FB2B5R6J	CHIP R 5.6 J 1/8W		R530			RK73GB2A473J	CHIP R 47K J 1/10W	

PARTS LIST / 零件表

TX-RX UNIT (X57-5963-01)

Ref. No.	Address	New parts	Parts No.	Description	Destination	Ref. No.	Address	New parts	Parts No.	Description	Destination
R531			RK73GB2A564J	CHIP R 560K J 1/10W		R594			RK73GB2A392J	CHIP R 3.9K J 1/10W	
R532			RK73GB2A103J	CHIP R 10K J 1/10W		R595			RK73GB2A181J	CHIP R 180 J 1/10W	
R533			RK73GB2A564J	CHIP R 560K J 1/10W		R598			RK73GB2A473J	CHIP R 47K J 1/10W	
R534			RK73GB2A474J	CHIP R 470K J 1/10W		R599,600			RK73GB2A102J	CHIP R 1.0K J 1/10W	
R535			RK73GB2A103J	CHIP R 10K J 1/10W		R602			RK73GB2A473J	CHIP R 47K J 1/10W	
R536			RK73GB2A153J	CHIP R 15K J 1/10W		R603			RK73GB2A101J	CHIP R 100 J 1/10W	
R537			RK73GB2A105J	CHIP R 1.0M J 1/10W		R604			RK73GB2A472J	CHIP R 4.7K J 1/10W	
R538			RK73GB2A103J	CHIP R 10K J 1/10W		R605			RK73GB2A332J	CHIP R 3.3K J 1/10W	
R539			RK73GB2A000J	CHIP R 0.0 J 1/10W		R606			RK73GB2A102J	CHIP R 1.0K J 1/10W	
R540			RK73GB2A223J	CHIP R 22K J 1/10W		R607			RK73GB2A101J	CHIP R 100 J 1/10W	
R541			RK73GB2A184J	CHIP R 180K J 1/10W		R608			RK73GB2A122J	CHIP R 1.2K J 1/10W	
R542			RK73GB2A102J	CHIP R 1.0K J 1/10W		R610,611			RK73GB2A473J	CHIP R 47K J 1/10W	
R543			RK73GB2A184J	CHIP R 180K J 1/10W		R612			RK73RB2H221J	CHIP R 220 J 1/2W	
R544			RK73GB2A103J	CHIP R 10K J 1/10W		R613			RK73GB2A103J	CHIP R 10K J 1/10W	
R545			RK73GB2A472J	CHIP R 4.7K J 1/10W		R614,615			RK73GB2A000J	CHIP R 0.0 J 1/10W	
R546			RN73GH1J913D	CHIP R 91K D 1/16W		R616			RK73GB2A474J	CHIP R 470K J 1/10W	
R547			RK73GB2A103J	CHIP R 10K J 1/10W		R617			RK73GB2A472J	CHIP R 4.7K J 1/10W	
R548			RN73GH1J333D	CHIP R 33K D 1/16W		R618			RK73GB2A683J	CHIP R 68K J 1/10W	
R549			RN73GH1J913D	CHIP R 91K D 1/16W		R619			RK73GB2A104J	CHIP R 100K J 1/10W	
R550			RN73GH1J683D	CHIP R 68K D 1/16W		R620,621			RK73GB2A103J	CHIP R 10K J 1/10W	
R551,552			RK73GB2A223J	CHIP R 22K J 1/10W		R622			RK73GB2A473J	CHIP R 47K J 1/10W	
R553			RK73GB2A105J	CHIP R 1.0M J 1/10W		R630			RK73GB2A000J	CHIP R 0.0 J 1/10W	
R554			RN73GH1J913D	CHIP R 91K D 1/16W		R641,642			RK73GB2A000J	CHIP R 0.0 J 1/10W	
R555,556			RK73GB2A104J	CHIP R 100K J 1/10W		R701			RK73GB2A683J	CHIP R 68K J 1/10W	
R557			RN73GH1J274D	CHIP R 270K D 1/16W		R704			RK73GB2A223J	CHIP R 22K J 1/10W	
R558			RK73GB2A000J	CHIP R 0.0 J 1/10W		R720			RK73GB2A000J	CHIP R 0.0 J 1/10W	
R559			RK73GB2A333J	CHIP R 33K J 1/10W		R722			RK73GB2A000J	CHIP R 0.0 J 1/10W	
R560			RK73GB2A474J	CHIP R 470K J 1/10W		R724			RK73GB2A473J	CHIP R 47K J 1/10W	
R561			RK73GB2A273J	CHIP R 27K J 1/10W		R726			RK73GB2A000J	CHIP R 0.0 J 1/10W	
R562			RK73GB2A000J	CHIP R 0.0 J 1/10W		D1	*	DA204U	DIODE		
R563			RK73GB2A473J	CHIP R 47K J 1/10W		D2		02DZ20(Y,Z)	ZENER DIODE		
R564			RK73GB2A223J	CHIP R 22K J 1/10W		D3-5	*	DA204U	DIODE		
R565			RK73GB2A000J	CHIP R 0.0 J 1/10W		D8		DAN235E	DIODE		
R566			RK73GB2A563J	CHIP R 56K J 1/10W		D9		1SS355	DIODE		
R567			RK73GB2A334J	CHIP R 330K J 1/10W		D10		DAN235E	DIODE		
R568			RK73GB2A473J	CHIP R 47K J 1/10W		D11		MA742	DIODE		
R569			RK73GB2A102J	CHIP R 1.0K J 1/10W		D14		1SS355	DIODE		
R570			RK73GB2A155J	CHIP R 1.5M J 1/10W		D15		DAN202K	DIODE		
R571			RN73GH1J682D	CHIP R 6.8K D 1/16W		D16		DAN235E	DIODE		
R572			RK73GB2A473J	CHIP R 47K J 1/10W		D17	*	DA204U	DIODE		
R573			RK73GB2A474J	CHIP R 470K J 1/10W		D18		KV1848K	VARIABLE CAPACITANCE DIODE		
R574			RN73GH1J683D	CHIP R 68K D 1/16W		D19,20		1SS355	DIODE		
R575			RK73GB2A101J	CHIP R 100 J 1/10W		D21		02DZ18F-X,Y	ZENER DIODE		
R576			RK73GB2A224J	CHIP R 220K J 1/10W		D23		KV1848K	VARIABLE CAPACITANCE DIODE		
R577			RK73GB2A103J	CHIP R 10K J 1/10W		D24		02DZ15(X,Y)	ZENER DIODE		
R578			RN73GH1J682D	CHIP R 6.8K D 1/16W		D25		ZSH5MA27	SURGE ABSORBER		
R579			RK73GB2A223J	CHIP R 22K J 1/10W		D26		DSA3A1-FK	DIODE		
R580			RK73GB2A000J	CHIP R 0.0 J 1/10W		D27		1SS355	DIODE		
R581	*		RK73GH2A434F	CHIP R 430K F 1/10W		D28		KV1848K	VARIABLE CAPACITANCE DIODE		
R582			RK73GB2A473J	CHIP R 47K J 1/10W		D30		MA4PH633	DIODE		
R583			RK73GB2A470J	CHIP R 47 J 1/10W		D31		KV1848K	VARIABLE CAPACITANCE DIODE		
R584			RK73GB2A220J	CHIP R 22 J 1/10W		D33,34		XB15A709	DIODE		
R585			RK73GB2A000J	CHIP R 0.0 J 1/10W		D35,36		MA742	DIODE		
R586			RK73GB2A473J	CHIP R 47K J 1/10W		D39		UDZS4.7B	ZENER DIODE		
R587			RK73GB2A000J	CHIP R 0.0 J 1/10W		D40		RB706F-40	DIODE		
R588			RK73GB2A103J	CHIP R 10K J 1/10W		D42		HZU5ALL	DIODE		
R590			RK73GB2A333J	CHIP R 33K J 1/10W		D54		MA2S111	DIODE		
R591			RK73GB2A000J	CHIP R 0.0 J 1/10W		D56		HZU5CLL	ZENER DIODE		
R592			RK73GB2A103J	CHIP R 10K J 1/10W		D501-504		MA2S111	DIODE		
R593			RK73GB2A181J	CHIP R 180 J 1/10W							

PARTS LIST / 零件表

TX-RX UNIT (X57-5963-01)

PLL/VCO (X58-4670-17)

Ref. No.	Address	New parts	Parts No.	Description	Destination
D506			MA2S111	DIODE	
D508			RB706F-40	DIODE	
D523			DAN202U	DIODE	
D524,525		*	DA204U	DIODE	
D526			1812L075PR	VARISTOR	
D527,528		*	DA204U	DIODE	
D529			RB706F-40	DIODE	
IC1,2			TA75S01F	IC (OP AMP)	
IC3			MB15A02	IC	
IC4			NJM4558M	IC (OP AMP X2)	
IC5			TA31136FNG	IC (FM IF DETECTOR)	
IC6			M62363FP	IC (8bit D/A CONVERTER)	
IC7			NJM2904M	IC (OP AMP X2)	
IC9			BU4094BCF	IC (8-STAGE SHIFT/STORE REGISTER)	
IC10			NJM78L05UA	IC (VOLTAGE REGULATOR/+5V)	
IC11			AN8009M	IC (REGULATOR)	
IC12			TA7808S	IC (REGULATOR)	
IC13			LA4422	IC (AF POWER AMP/5.8W)	
IC14			TC4013BF(N)	IC (MEMORY)	
IC15			TA75S01F	IC (OP AMP)	
IC400	2C		RA30H4452M-31	IC (RF MODULE 440-490MHz)	
IC501		*	AT29C02090TU	IC	
IC502			30622M4A-439GP	MPU	
IC503			RH5VL42C	IC (REGULATOR)	
IC505			AT24C08A10SU18	IC (8bit SERIAL EEPROM)	
IC507			NJM2904V	IC (APC)	
IC508			TC35453F	IC (AUDIO PROCESSOR)	
IC509			BU4066BCFV	IC (ANALOG SWITCHX4)	
IC510			BU4094BCFV	IC (8-STAGE SHIFT/STORE REGISTER)	
IC511			LC73872M	IC (DTMF RECEIVER)	
IC512			NJM78L05UA	IC (VOLTAGE REGULATOR)	
IC513			TA75W558FU	IC (OP AMP X2)	
IC514			TC75W51FUF	IC (OP AMP X2)	
Q1			DTD114EK	DIGITAL TRANSISTOR	
Q2			KRA225S	DIGITAL TRANSISTOR	
Q3			DTA114EKA	DIGITAL TRANSISTOR	
Q4,5			DTC114EKA	DIGITAL TRANSISTOR	
Q6			DTC124EKA	DIGITAL TRANSISTOR	
Q7			2SC4649(N,P)	TRANSISTOR	
Q8			2SC2412K	TRANSISTOR	
Q9			2SC4226(R24)	TRANSISTOR	
Q10			2SC2412K	TRANSISTOR	
Q11			2SA1774(R)	TRANSISTOR	
Q12			2SC4617(R)	TRANSISTOR	
Q13			2SC4649(N,P)	TRANSISTOR	
Q14			2SC5110(O)	TRANSISTOR	
Q15			3SK255	FET	
Q16			DTC114EKA	DIGITAL TRANSISTOR	
Q17			DTC363EU	DIGITAL TRANSISTOR	
Q18			2SA1745(6,7)	TRANSISTOR	
Q19			DTC114EKA	DIGITAL TRANSISTOR	
Q20			DTA114EKA	DIGITAL TRANSISTOR	
Q21			DTC114EKA	DIGITAL TRANSISTOR	
Q22			2SC4093	TRANSISTOR	
Q23			2SA1641(S,T)	TRANSISTOR	
Q24			DTA114EKA	DIGITAL TRANSISTOR	
Q26			DTA114EKA	DIGITAL TRANSISTOR	
Q27			2SC2954	TRANSISTOR	
Q28			2SB1132(Q,R)	TRANSISTOR	
Q29			DTC114EKA	DIGITAL TRANSISTOR	
Q33			DTC114EKA	DIGITAL TRANSISTOR	
Q34			3SK255	FET	
Q35			DTC144EKA	DIGITAL TRANSISTOR	
Q36			2SC2412K	TRANSISTOR	
Q37,38			2SK1824	FET	
Q501			2SC4649(N,P)	TRANSISTOR	
Q502,503			DTC114EE	DIGITAL TRANSISTOR	
Q504			2SC4617(S)	TRANSISTOR	
Q505			2SB1132(Q,R)	TRANSISTOR	
Q506			DTC114EE	DIGITAL TRANSISTOR	
Q508			2SC4617(S)	TRANSISTOR	
Q509			DTC363EU	DIGITAL TRANSISTOR	
TH1			157-153-65001	THERMISTOR	
TH2		*	B57331V2682J	THERMISTOR	
PLL/VCO (X58-4670-17)					
C102			CK73GB1H471K	CHIP C 470PF	K
C104			CC73GCH1H120J	CHIP C 12PF	J
C105			CC73GCH1H070D	CHIP C 7.0PF	D
C107			CC73GCH1H060D	CHIP C 6.0PF	D
C108			CC73GCH1HR75B	CHIP C 0.75PF	B
C110			CC73GCH1H030B	CHIP C 3.0PF	B
C111			CC73GCH1H050B	CHIP C 5.0PF	B
C112			CC73GCH1H1R5B	CHIP C 1.5PF	B
C113			CC73GCH1H010B	CHIP C 1.0PF	B
C114			CC73GCH1H040B	CHIP C 4.0PF	B
C115			CC73GCH1H060D	CHIP C 6.0PF	D
C116			CC73GCH1H050B	CHIP C 5.0PF	B
C117			CK73GB1H471K	CHIP C 470PF	K
C118			CC73GCH1H050B	CHIP C 5.0PF	B
C119,120			CK73GB1H471K	CHIP C 470PF	K
C121			CC73GCH1H050B	CHIP C 5.0PF	B
C122			CC73GCH1H0R5B	CHIP C 0.5PF	B
C123			CK73GB1H471K	CHIP C 470PF	K
C124			CC73GCH1H0R5B	CHIP C 0.5PF	B
C125			CK73GB1H102K	CHIP C 1000PF	K
C126			CK73GB1H471K	CHIP C 470PF	K
C127			CC73GCH1H050B	CHIP C 5.0PF	B
TC106			C05-0384-05	CERAMIC TRIMMER CAPACITOR (10P)	
TC109			C05-0384-05	CERAMIC TRIMMER CAPACITOR (10P)	
CN101			E40-6019-05	PIN ASSY	
-			F10-2279-04	SHIELDING CASE	
L101-104		*	L41-1595-33	SMALL FIXED INDUCTOR (1.5UH)	
L105		*	L41-3975-33	SMALL FIXED INDUCTOR (0.039UH)	
L106		*	L41-2775-33	SMALL FIXED INDUCTOR (0.027UH)	
L107,108			L40-1098-76	SMALL FIXED INDUCTOR (1UH)	
L109,110		*	L41-1595-33	SMALL FIXED INDUCTOR (1.5UH)	
L111			L34-4547-05	AIR-CORE COIL	
L115			L34-4547-05	AIR-CORE COIL	
R101,102			RK73GB2A101J	CHIP R 100 J 1/10W	
R103			RK73GB2A102J	CHIP R 1.0K J 1/10W	
R104			RK73GB2A101J	CHIP R 100 J 1/10W	
R105			RK73GB2A154J	CHIP R 150K J 1/10W	
R106			RK73GB2A470J	CHIP R 47 J 1/10W	
R107-110			RK73GB2A103J	CHIP R 10K J 1/10W	
R111			RK73GB2A331J	CHIP R 330 J 1/10W	

PARTS LIST / 零件表

PLL/VCO (X58-4670-17)

Ref. No.	Address	New parts	Parts No.	Description	Destination	Ref. No.	Address	New parts	Parts No.	Description	Destination
R112,113			RK73GB2A221J	CHIP R 220 J 1/10W							
R114			RK73GB2A470J	CHIP R 47 J 1/10W							
R115			RK73GB2A103J	CHIP R 10K J 1/10W							
R116			RK73GB2A392J	CHIP R 3.9K J 1/10W							
R117			RK73GB2A101J	CHIP R 100 J 1/10W							
D101-104		*	1SV283F	VARIABLE CAPACITANCE DIODE							
D105			1SV214	VARIABLE CAPACITANCE DIODE							
Q101			2SK508NV(52K)	FET							
Q102			DTC114EUA	DIGITAL TRANSISTOR							
Q103			2SK508NV(52K)	FET							
Q104,105			2SC4081	TRANSISTOR							
Q106			2SC4226(R24)	TRANSISTOR							

TK-868G PC BOARD / PC板

DISPLAY UNIT (X54-3270-10)
Component side view (J72-0683-02)

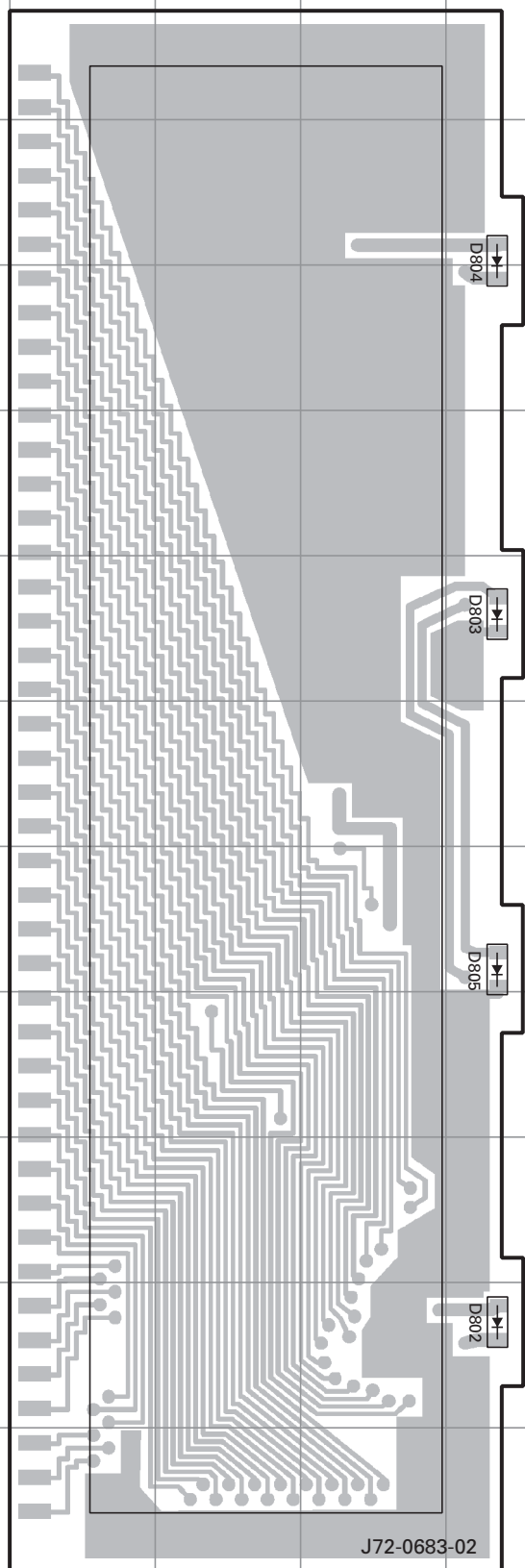

DISPLAY UNIT (X54-3270-10)
Foil side view (J72-0683-02)

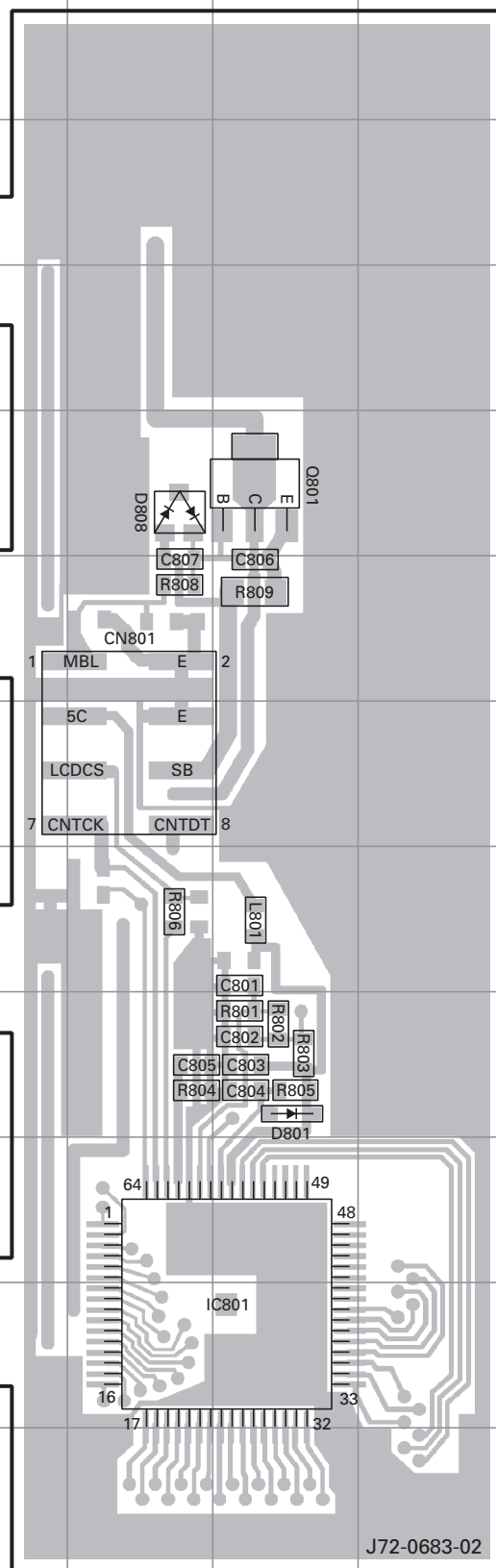

Ref. No.	Address
D802	11E
D803	6E
D804	3E
D805	8E

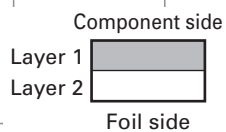

Ref. No.	Address
IC801	11H
Q801	5H
D801	9H
D808	5G

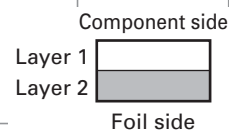

PLL/VCO (X58-4670-17) Component side view (J72-0676-02)

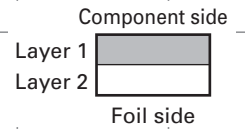
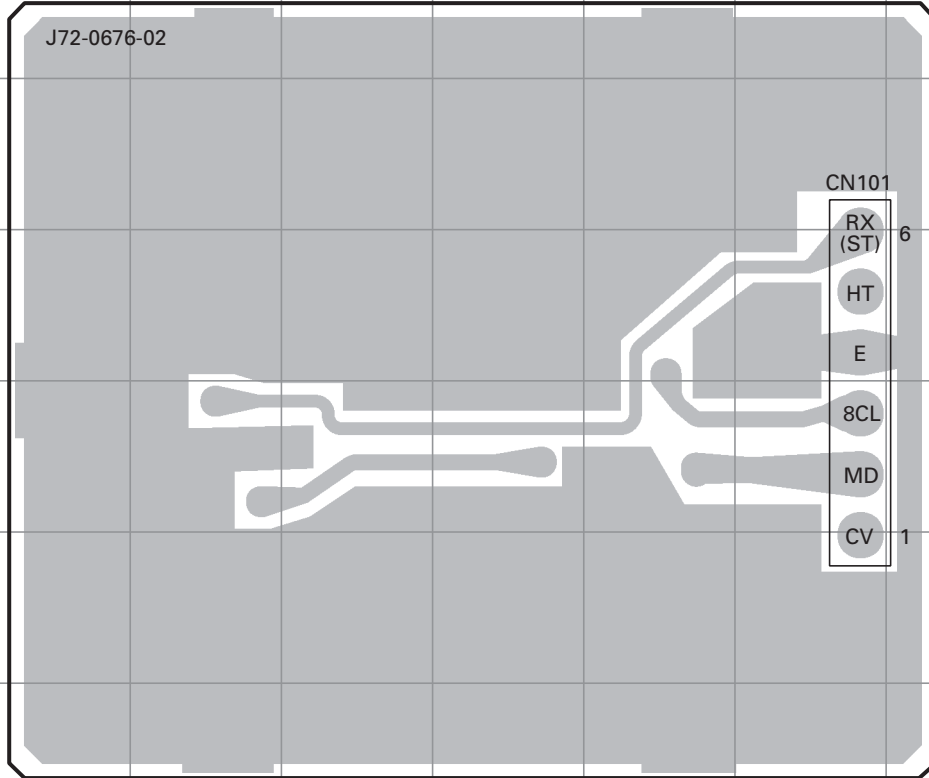

PLL/VCO (X58-4670-17) Foil side view (J72-0676-02)

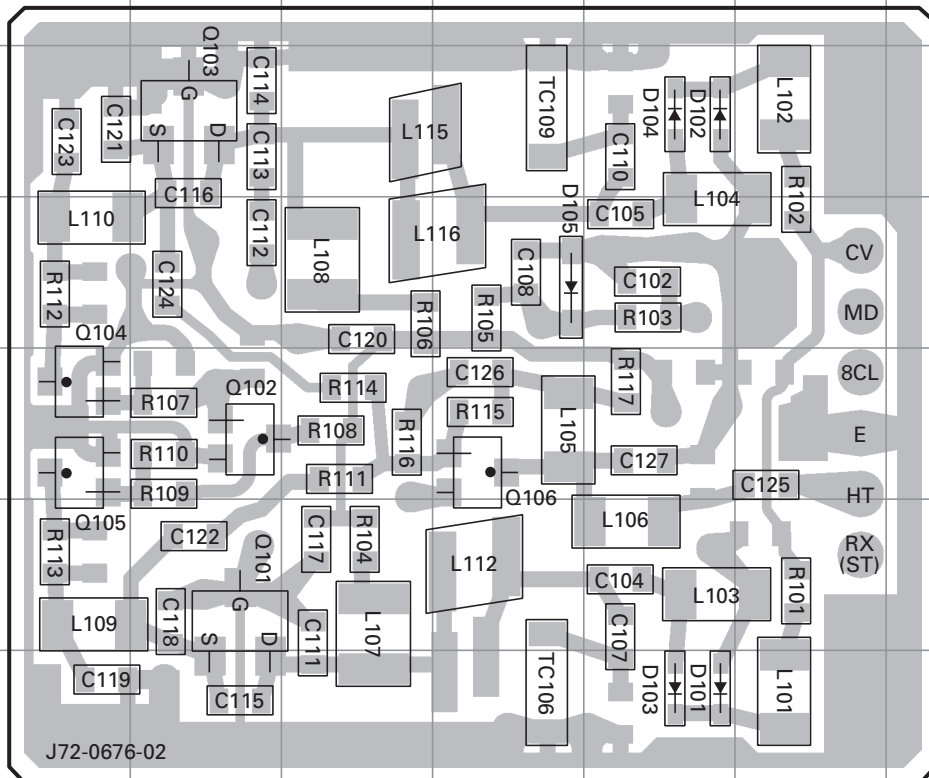

Ref. No.	Address
Q101	12C
Q102	11C
Q103	9C
Q104	11B
Q105	11B
Q106	11E
D101	13F
D102	9F
D103	13F
D104	9F
D105	10E

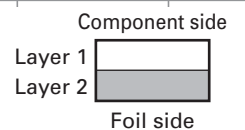

TK-868G PC BOARD / PC板

TX-RX UNIT (X57-5963-01) (A/2)

Component side view (J72-0988-09 A/2)

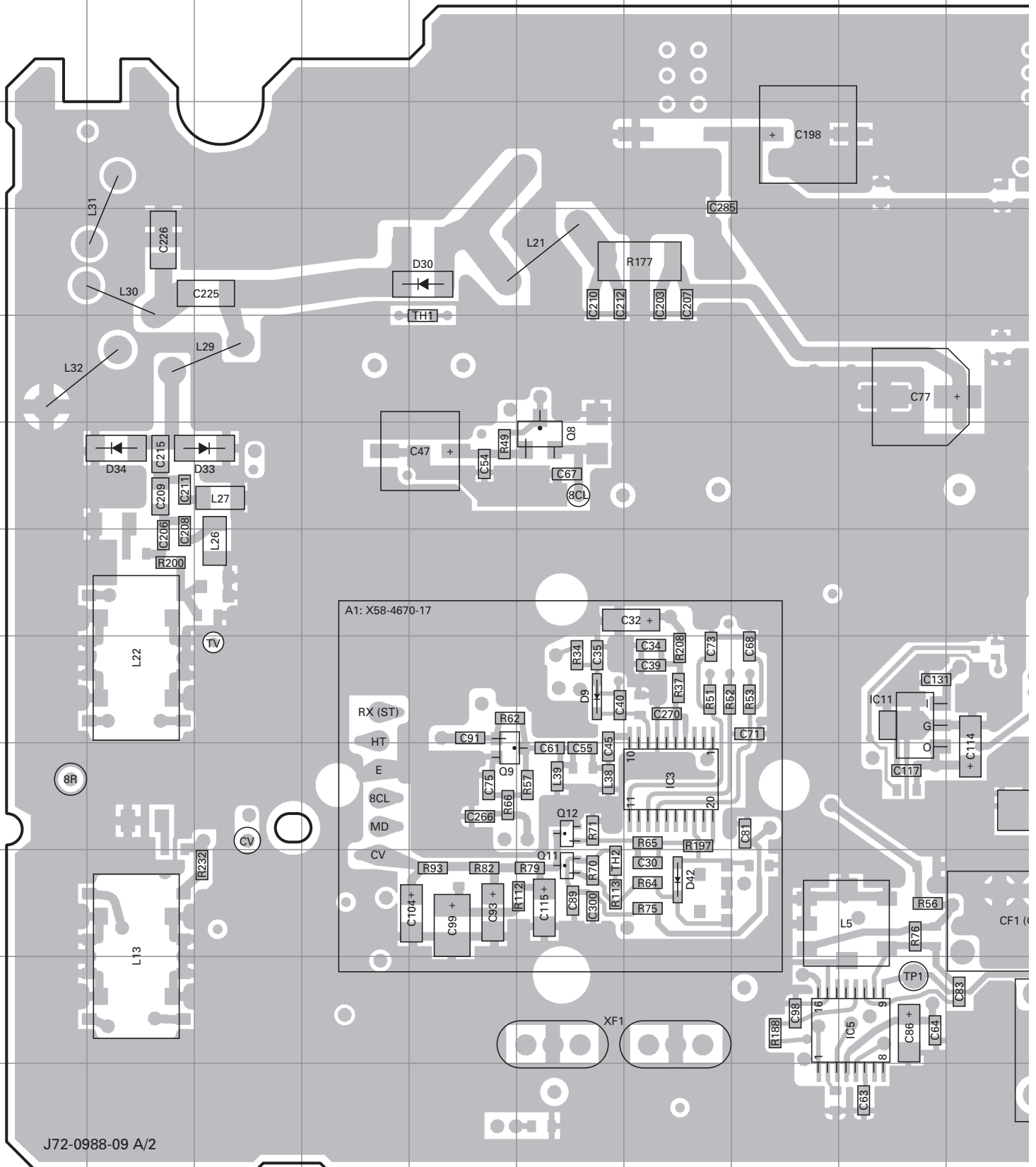

TK-868G PC BOARD / PC板

PC BOARD / PC板 TK-868G

TX-RX UNIT (X57-5963-01) (A/2)
Component side view (J72-0988-09 A/2)

TX-RX UNIT (X57-5963-01) (A/2)
Component side view (J72-0988-09 A/2)

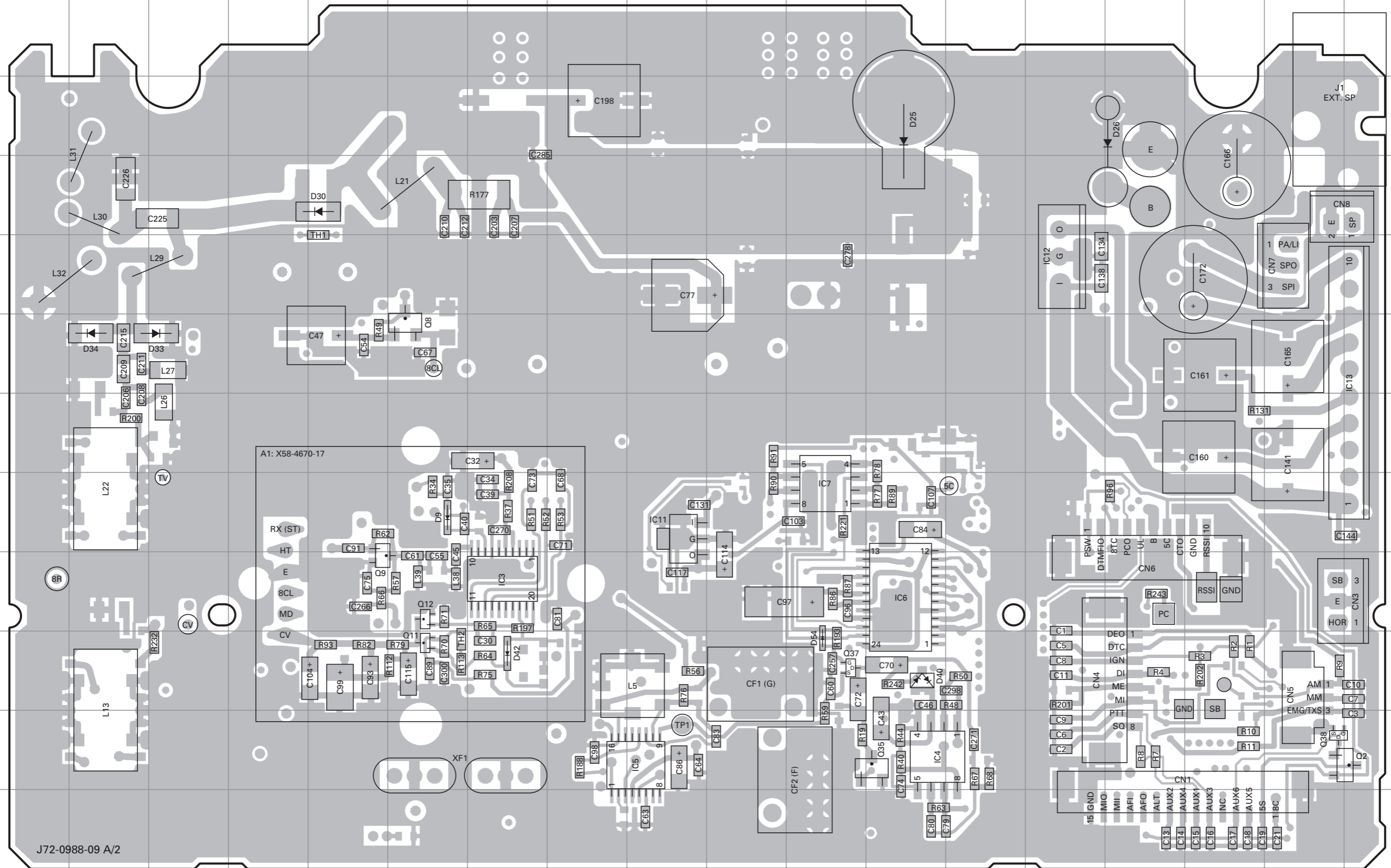

Ref. No.	Address
IC3	10G
IC4	12L
IC5	12I
IC6	10L
IC7	9K
IC11	9I
IC12	6N
IC13	7R
Q2	12R
Q8	7F
Q9	10E
Q11	11F
Q12	10F
Q35	12L
Q37	11K
Q38	12Q
D9	9F
D25	4L
D26	4O
D30	5E
D33	7C
D34	7B
D40	11L
D42	11G
D54	11K

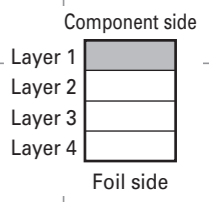

J72-0988-09 A/2

TK-868G PC BOARD / PC板

TX-RX UNIT (X57-5963-01) (A/2)
Foil side view (J72-0988-09 A/2)

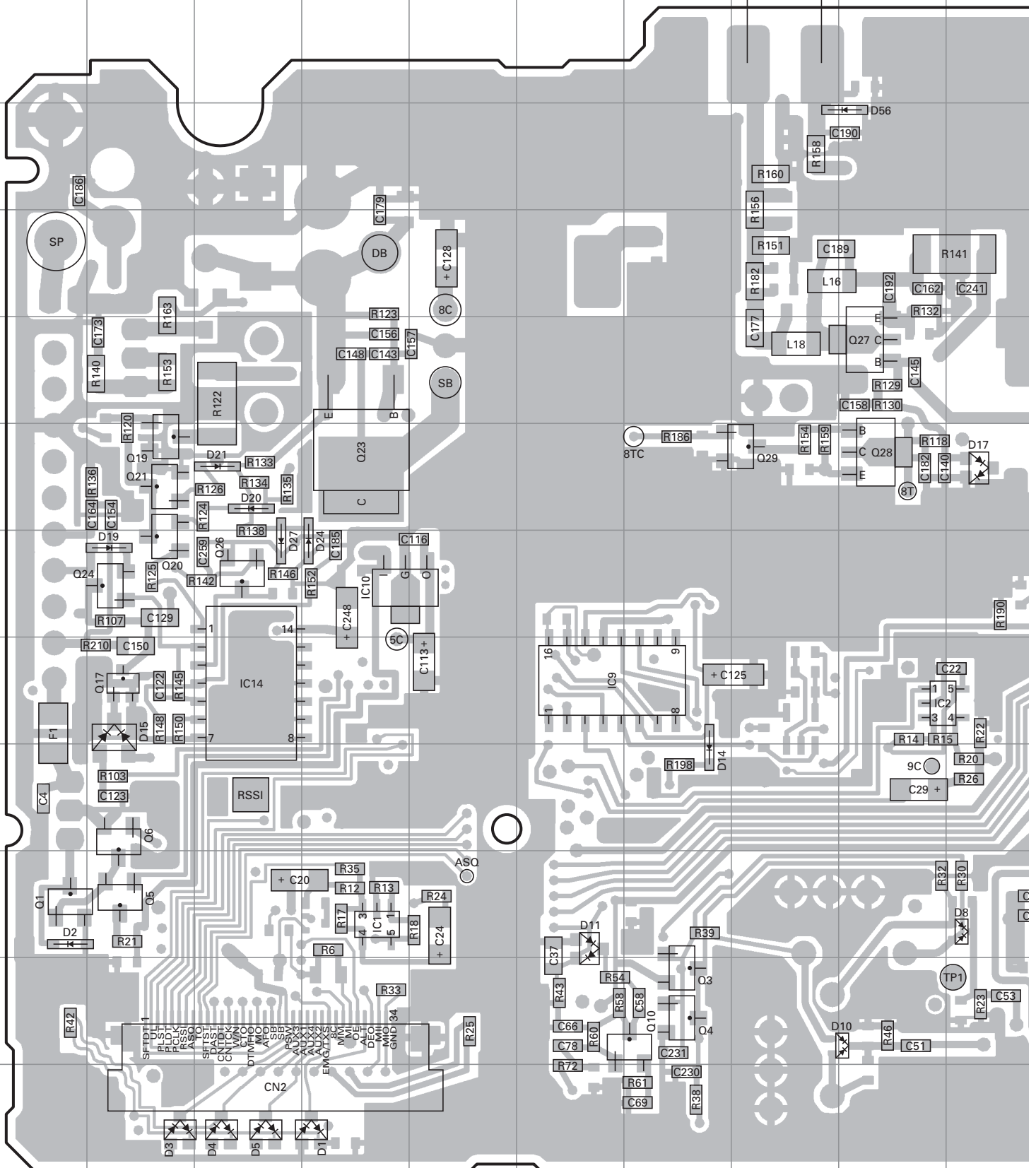

PC BOARD / PC板 TK-868G

TX-RX UNIT (X57-5963-01) (A/2)
Foil side view (J72-0988-09 A/2)

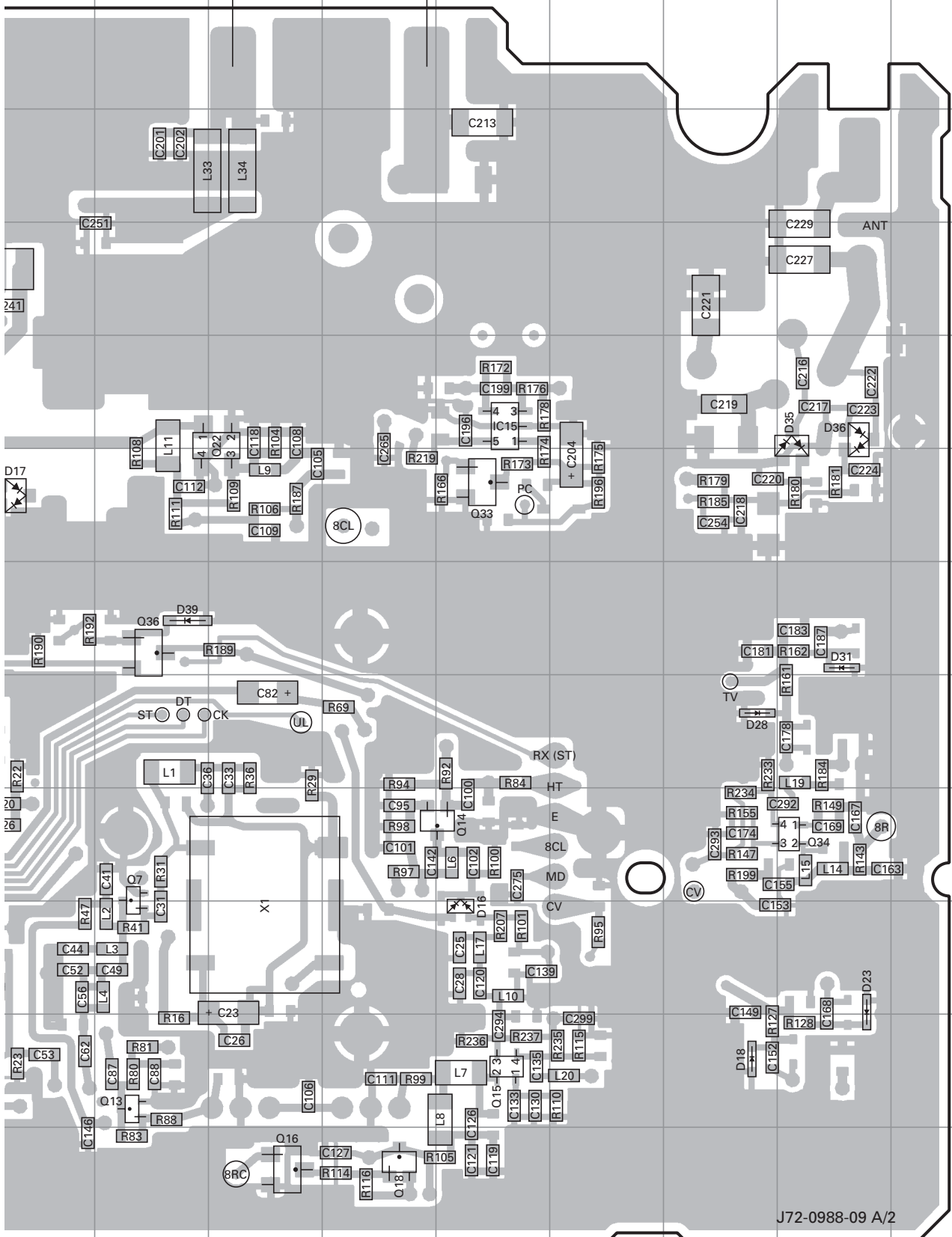

Ref. No.	Address
IC1	11D
IC2	9I
IC9	9F
IC10	8D
IC14	9C
IC15	6N
IC400	2J
Q1	11A
Q3	12G
Q4	12G
Q5	11B
Q6	10B
Q7	10K
Q10	12G
Q13	12K
Q14	10N
Q15	12N
Q16	13L
Q17	9B
Q18	13M
Q19	7B
Q20	8B
Q21	7B
Q22	6L
Q23	7D
Q24	8B
Q26	8C
Q27	6I
Q28	7I
Q29	7H
Q33	7N
Q34	10Q
Q36	8K
D1	13D
D2	11A
D3	13B
D4	13C
D5	13C
D8	11J
D10	12I
D11	11F
D14	10G
D15	9B
D16	11N
D17	7J
D18	12P
D19	8B
D20	7C
D21	7C
D23	11Q
D24	8D
D27	8C
D28	9P
D31	8Q
D35	6Q
D36	6Q
D39	8K
D56	4I

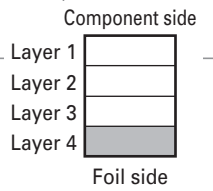

J72-0988-09 A/2

TK-868G PC BOARD / PC板

PC BOARD / PC板 TK-868G

TX-RX UNIT (X57-5963-01) (A/2)
Foil side view (J72-0988-09 A/2)

TX-RX UNIT (X57-5963-01) (A/2)
Foil side view (J72-0988-09 A/2)

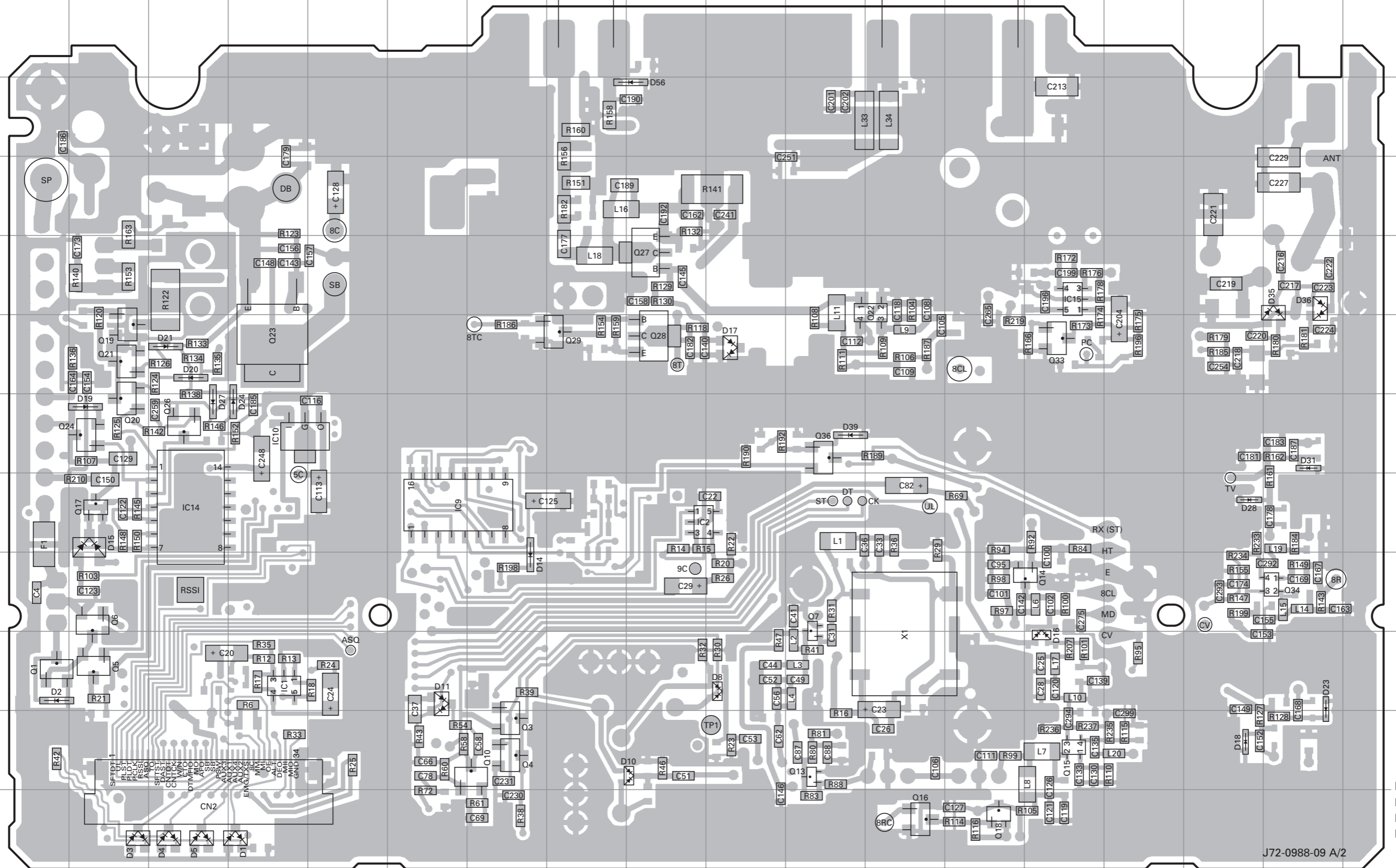

Ref. No.	Address
IC1	11D
IC2	9I
IC9	9F
IC10	8D
IC14	9C
IC15	6N
IC400	2J
Q1	11A
Q3	12G
Q4	12G
Q5	11B
Q6	10B
Q7	10K
Q10	12G
Q13	12K
Q14	10N
Q15	12N
Q16	13L
Q17	9B
Q18	13M
Q19	7B
Q20	8B
Q21	7B
Q22	6L
Q23	7D
Q24	8B
Q26	8C
Q27	6I
Q28	7I
Q29	7H
Q33	7N
Q34	10Q
Q36	8K
D1	13D
D2	11A
D3	13B
D4	13C
D5	13C
D8	11J
D10	12I
D11	11F
D14	10G
D15	9B
D16	11N
D17	7J
D18	12P
D19	8B
D20	7C
D21	7C
D23	11Q
D24	8D
D27	8C
D28	9P
D31	8Q
D35	6Q
D36	6Q
D39	8K
D56	4I

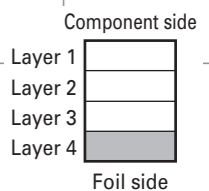

J72-0988-09 A/2

TK-868G PC BOARD / PC板

TX-RX UNIT (X57-5963-01) (B/2) Component side view (J72-0988-09 B/2)

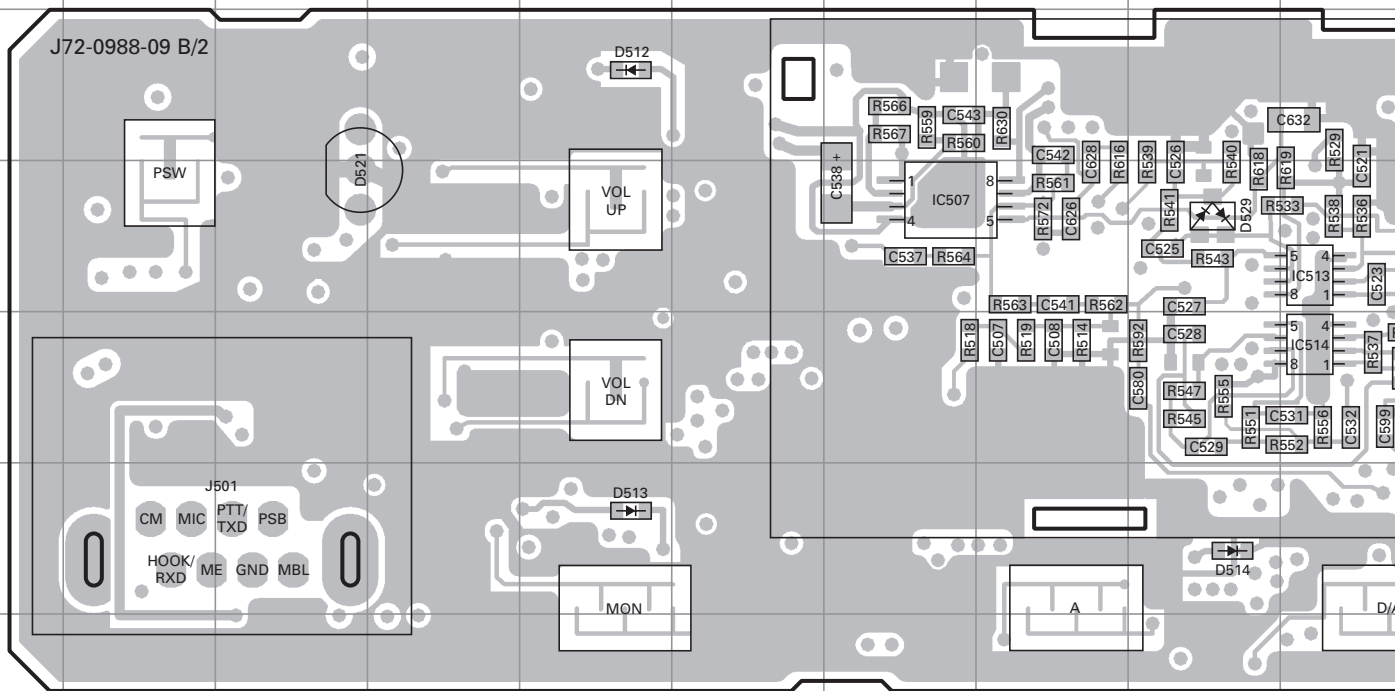

Ref. No.	Address	Ref. No.	Address	Ref. No.	Address	Ref. No.	Address
IC501	3O	IC513	3J	D510	5Q	D514	5I
IC503	4L	IC514	4J	D511	2Q	D521	3C
IC507	3G	D506	4L	D512	2E	D529	3I
IC510	3L	D509	5M	D513	5E		

TX-RX UNIT (X57-5963-01) (B/2) Foil side view (J72-0988-09 B/2)

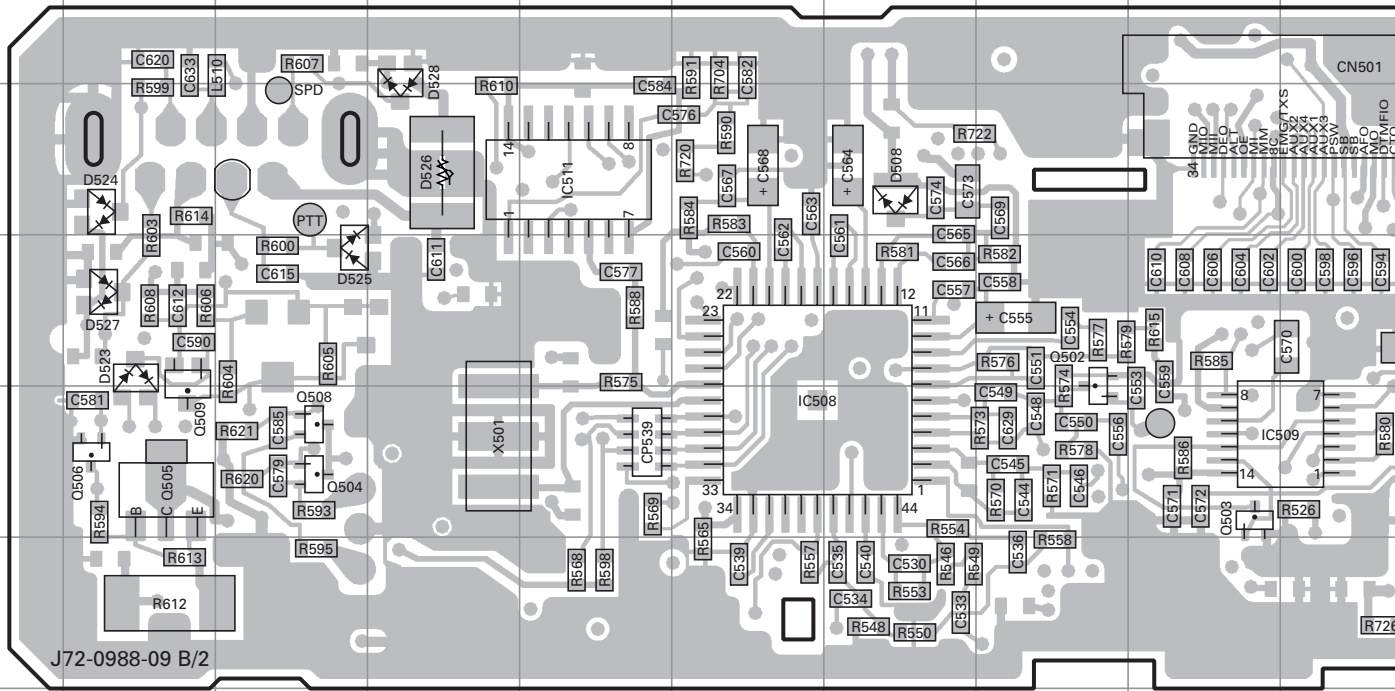

Ref. No.	Address	Ref. No.	Address	Ref. No.	Address	Ref. No.	Address	Ref. No.	Address	Ref. No.	Address	Ref. No.	Address
IC502	10P	IC511	9E	Q503	11I	Q508	11C	D503	10N	D524	9B	D528	8D
IC505	11N	IC512	10L	Q504	11C	Q509	11B	D504	11O	D525	10C		
IC508	11F	Q501	9R	Q505	11B	D501	11O	D508	9G	D526	9D		
IC509	11J	Q502	10H	Q506	11B	D502	11N	D523	10B	D527	10B		

PC BOARD / PC板 TK-868G

TX-RX UNIT (X57-5963-01) (B/2) Component side view (J72-0988-09 B/2)

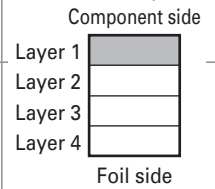
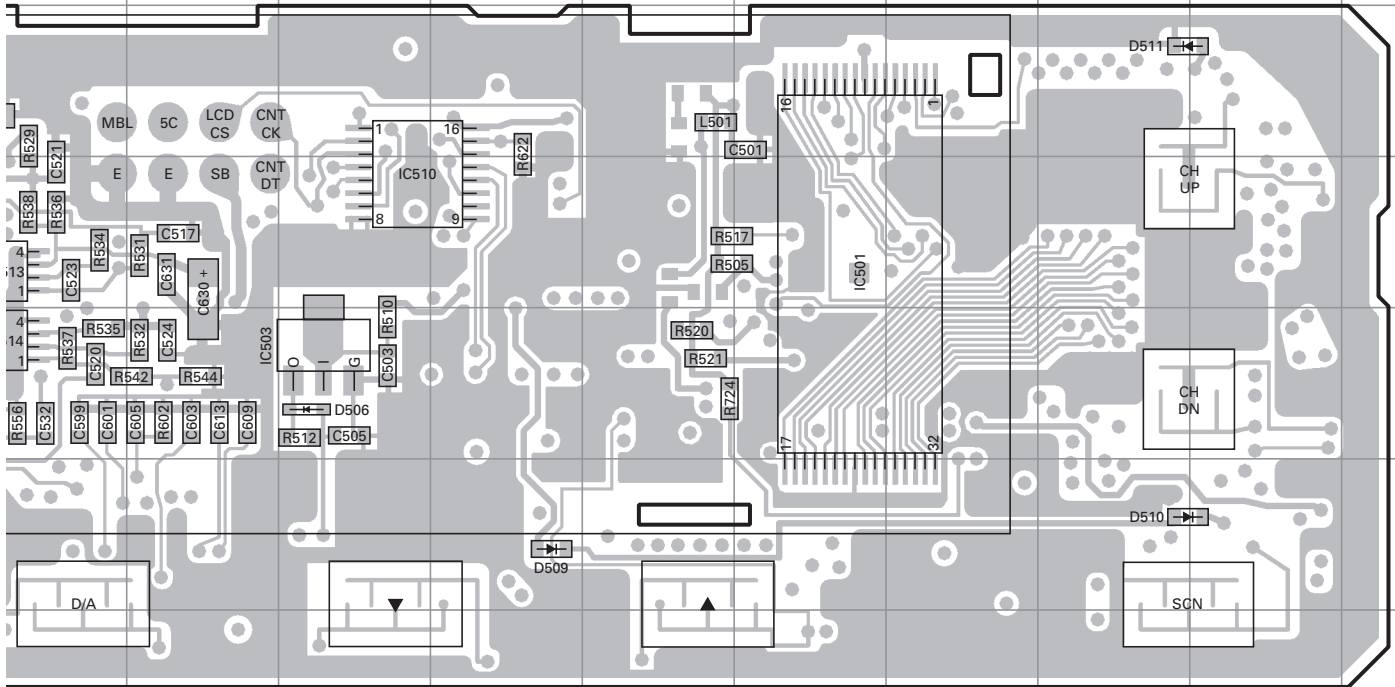

TX-RX UNIT (X57-5963-01) (B/2) Foil side view (J72-0988-09 B/2)

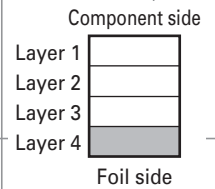
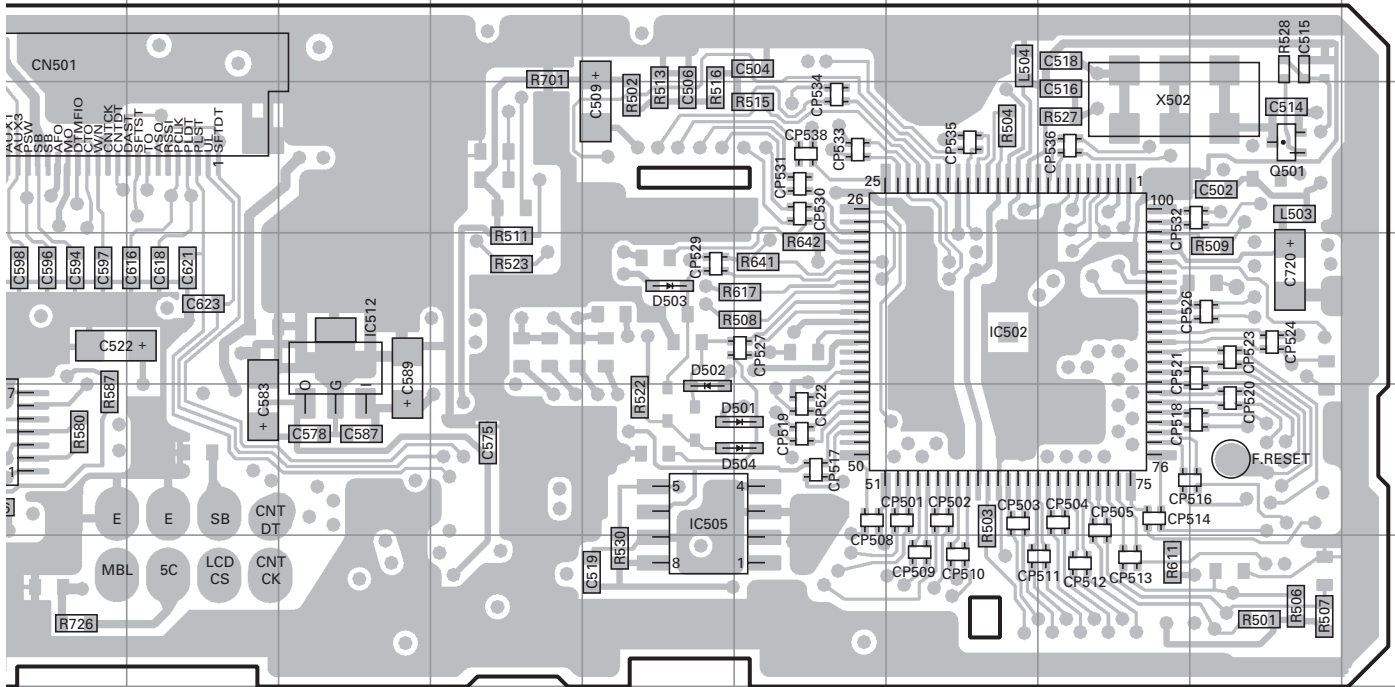

TK-868G PC BOARD / PC板

PC BOARD / PC板 TK-868G

TX-RX UNIT (X57-5963-01) (B/2) Component side view (J72-0988-09 B/2)

TX-RX UNIT (X57-5963-01) (B/2) Component side view (J72-0988-09 B/2)

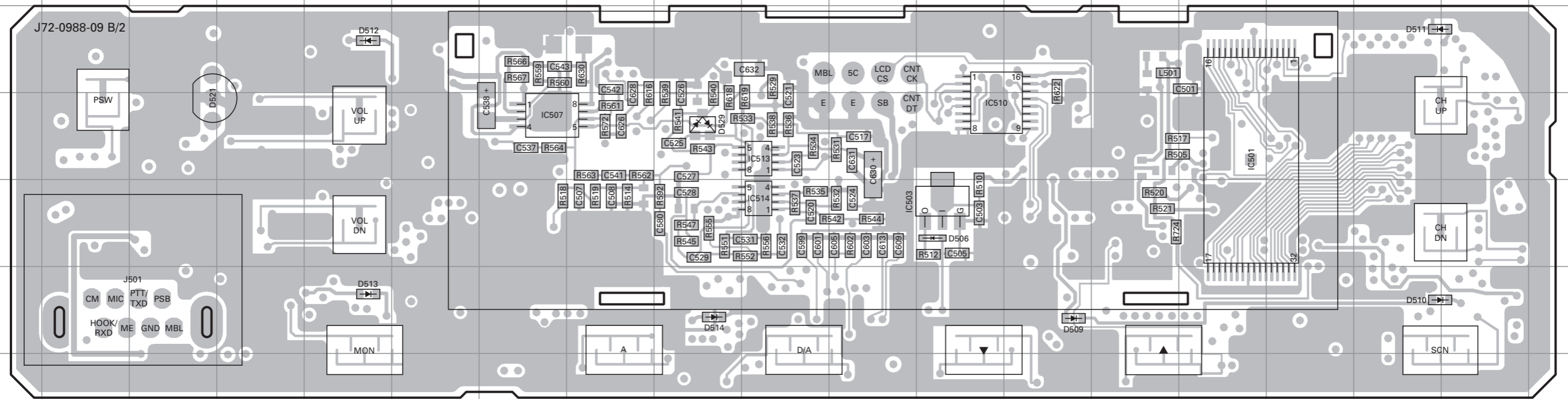

Ref. No.	Address	Ref. No.	Address	Ref. No.	Address	Ref. No.	Address
IC501	3O	IC513	3J	D510	5Q	D514	5I
IC503	4L	IC514	4J	D511	2Q	D521	3C
IC507	3G	D506	4L	D512	2E	D529	3I
IC510	3L	D509	5M	D513	5E		

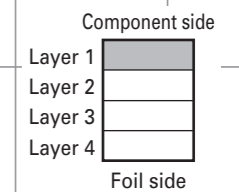

TX-RX UNIT (X57-5963-01) (B/2) Foil side view (J72-0988-09 B/2)

TX-RX UNIT (X57-5963-01) (B/2) Foil side view (J72-0988-09 B/2)

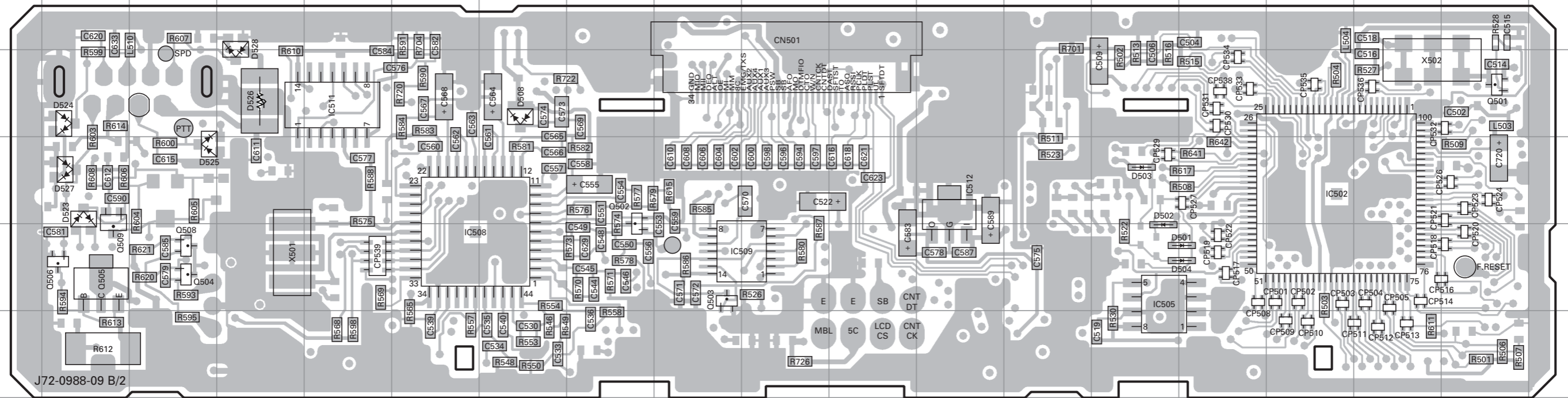

Ref. No.	Address	Ref. No.	Address	Ref. No.	Address	Ref. No.	Address	Ref. No.	Address	Ref. No.	Address
IC502	10P	IC511	9E	Q503	11I	Q508	11C	D503	10N	D524	9B
IC505	11N	IC512	10L	Q504	11C	Q509	11B	D504	11O	D525	10C
IC508	11F	Q501	9R	Q505	11B	D501	11O	D508	9G	D526	9D
IC509	11J	Q502	10H	Q506	11B	D502	11N	D523	10B	D527	10B

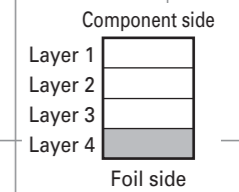

TK-868G SCHEMATIC DIAGRAM / 原理图

DISPLAY UNIT (X54-3270-10)

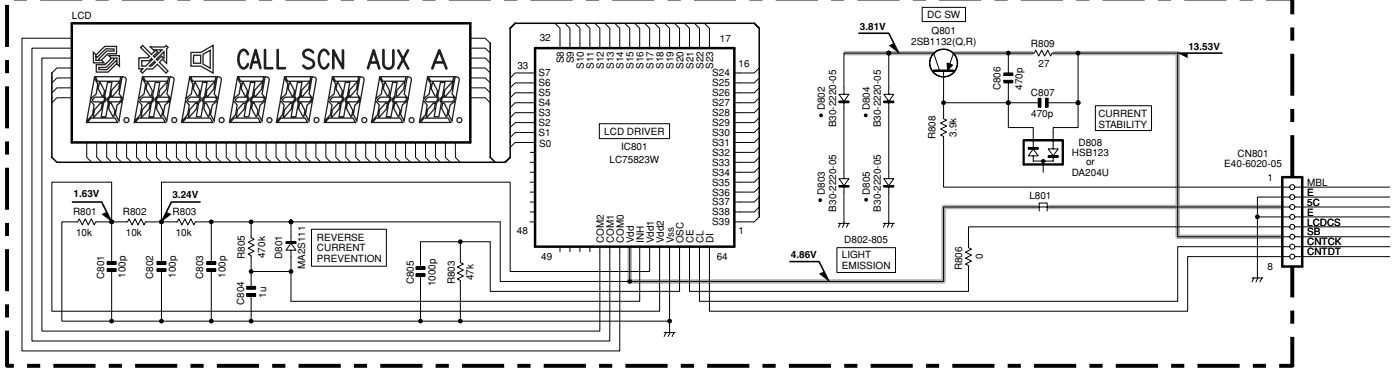

CONTROL UNIT (X57-5963-01) (B/2)

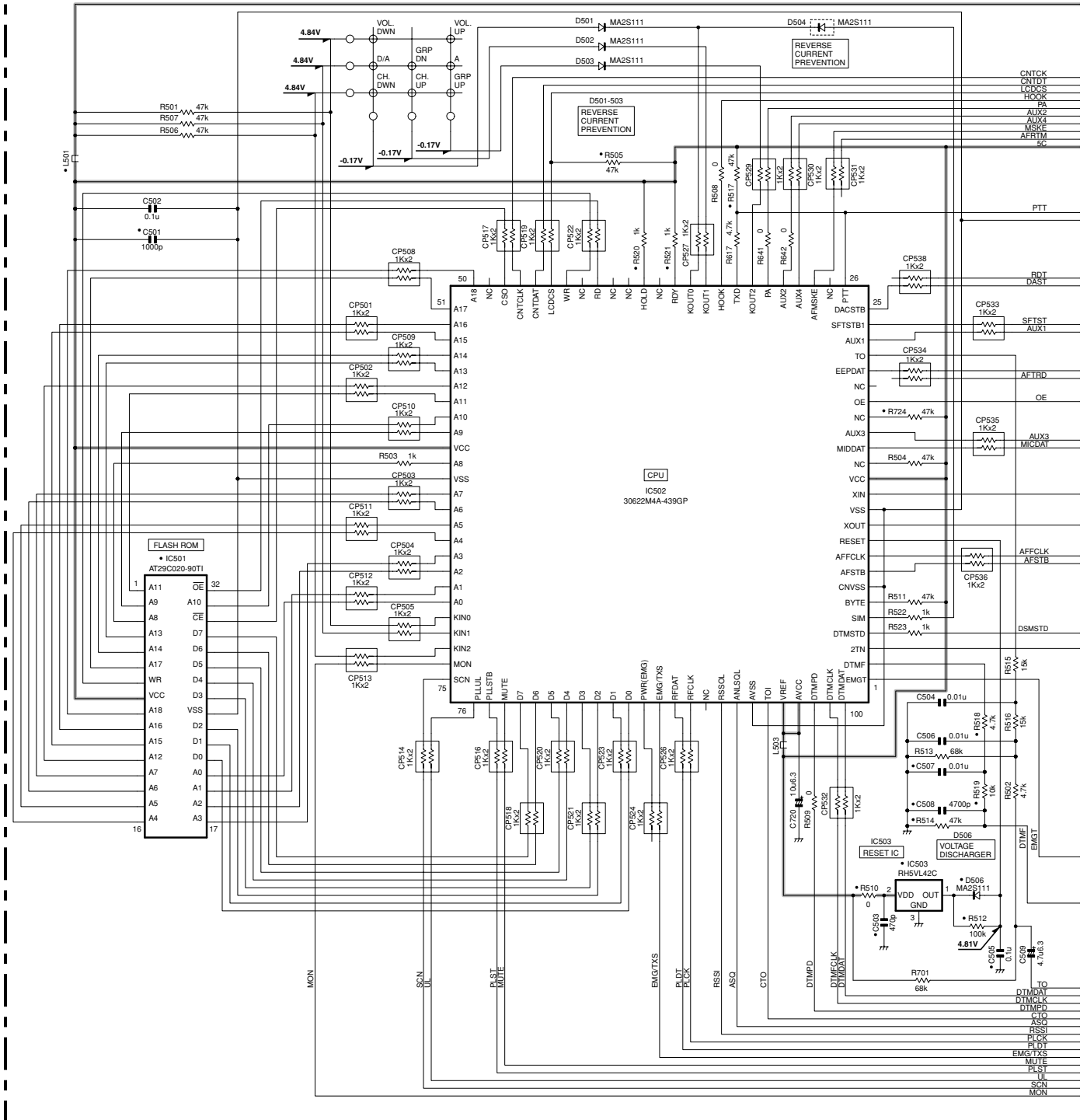

SCHEMATIC DIAGRAM / 原理图 TK-868G

CONTROL UNIT (X57-5963-01) (B/2)

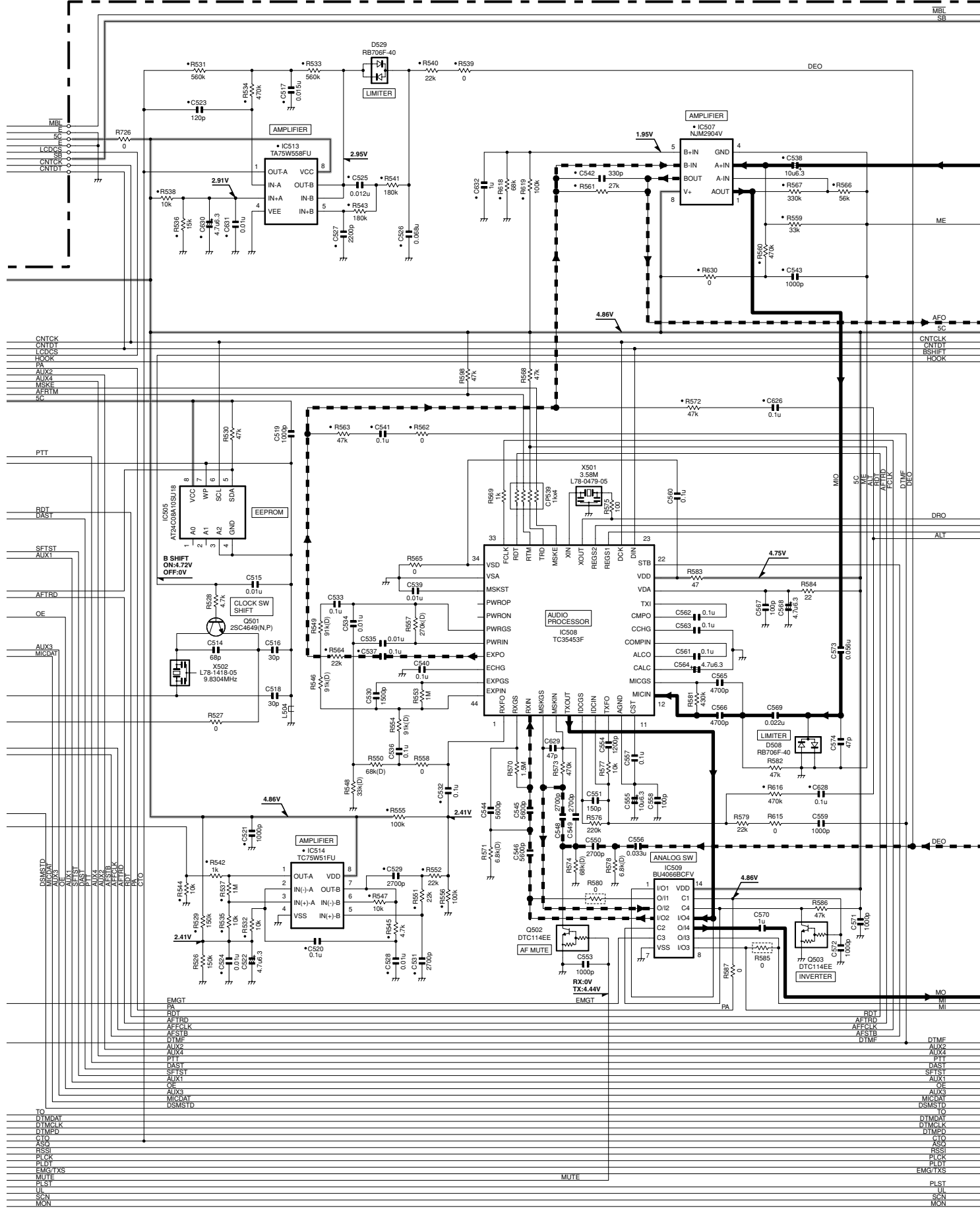

TK-868G SCHEMATIC DIAGRAM / 原理图

CONTROL UNIT (X57-5963-01) (B/2)

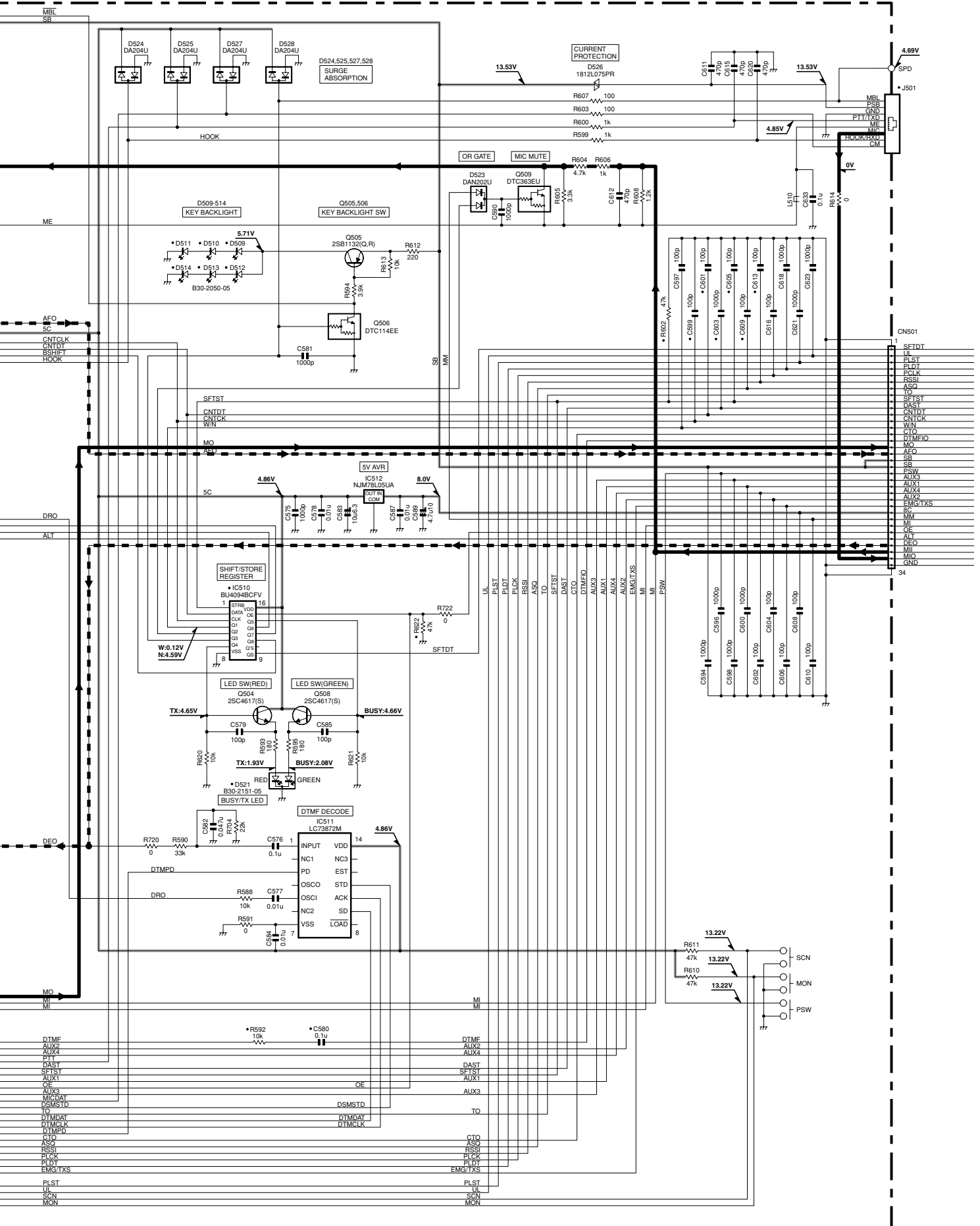

SCHEMATIC DIAGRAM / 原理图 TK-868G

TX-RX UNIT (X57-5963-01) (A/2)

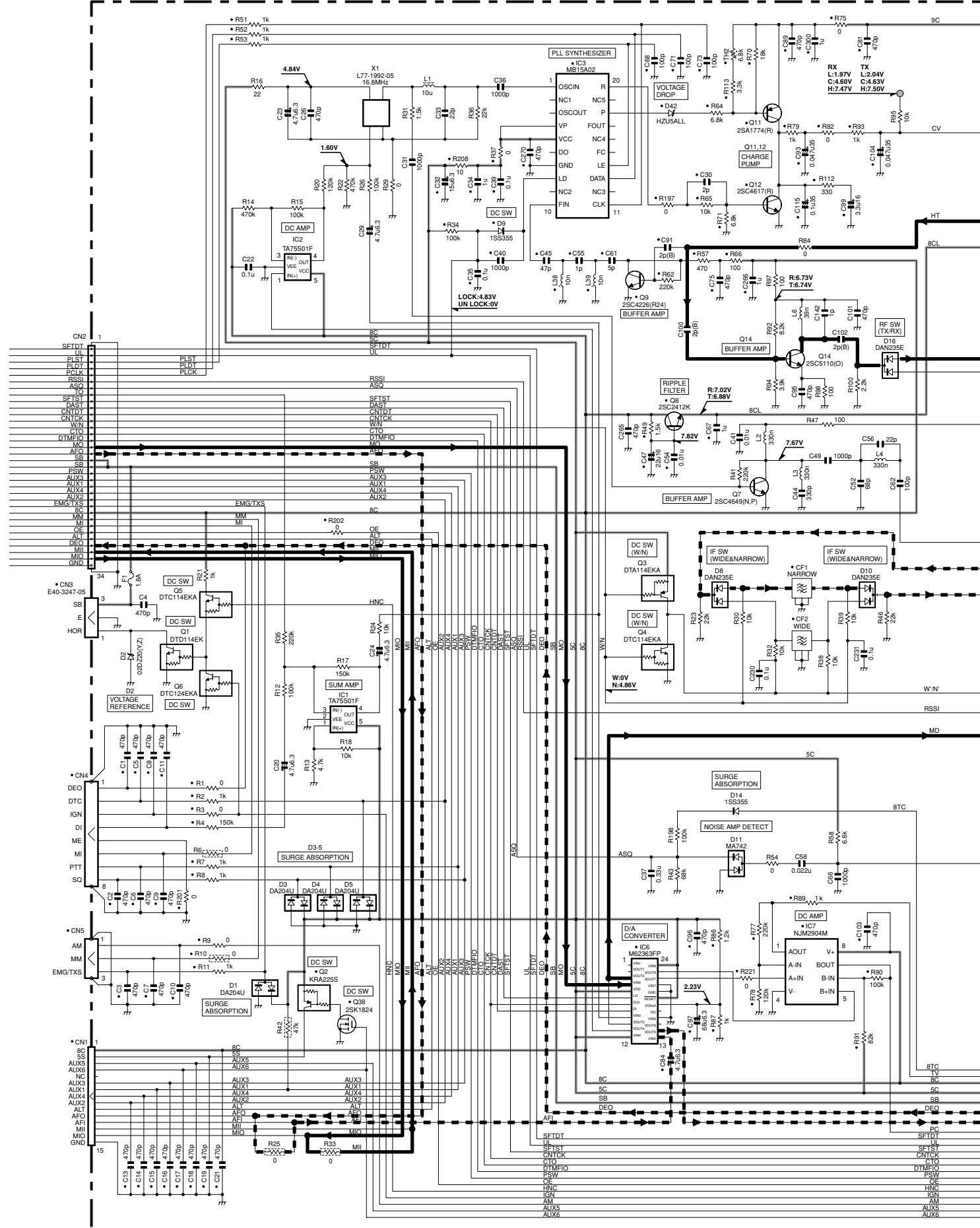

TK-868G SCHEMATIC DIAGRAM / 原理图

TX-RX UNIT (X57-5963-01) (A/2)

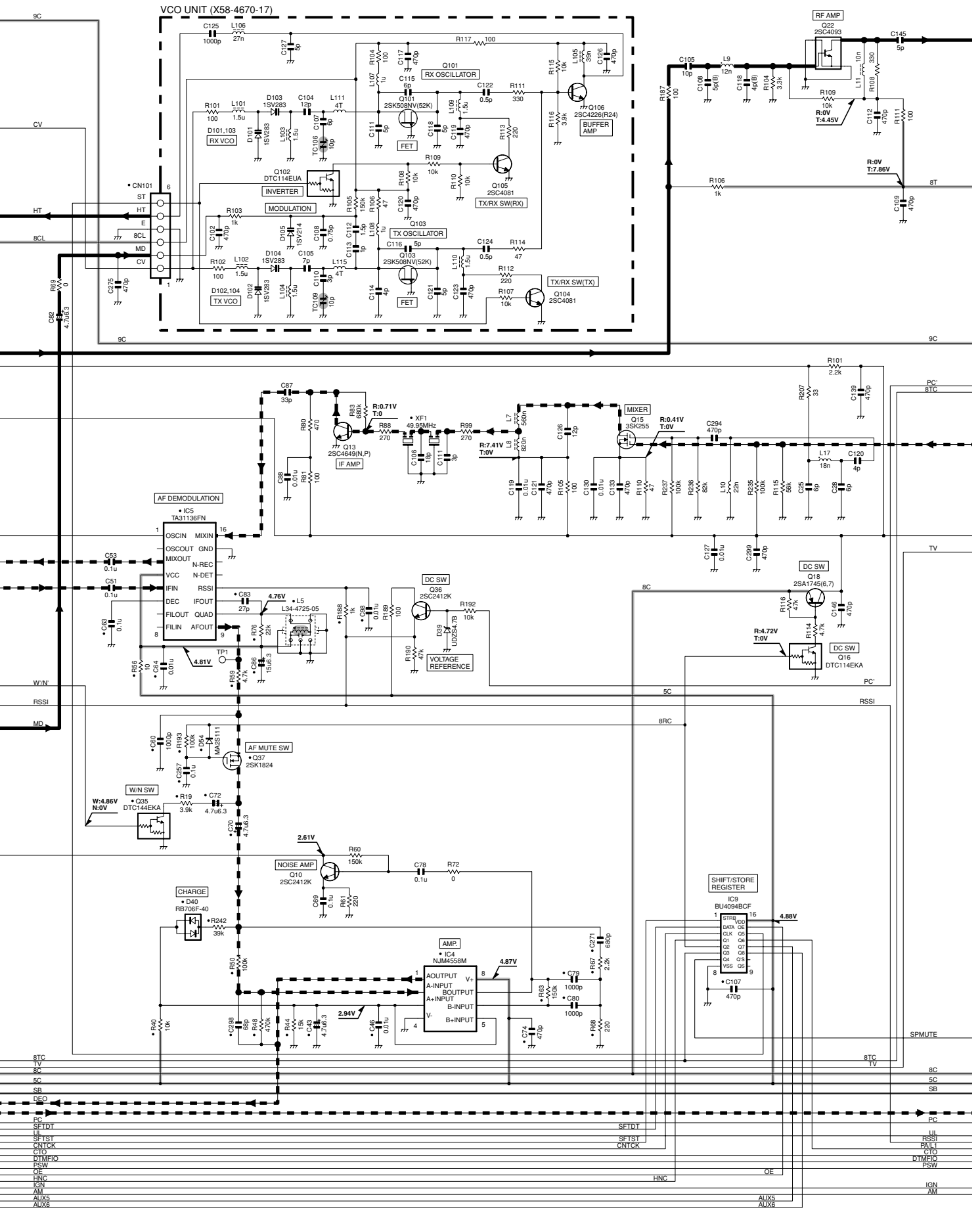

SCHEMATIC DIAGRAM / 原理图 TK-868G

TX-RX UNIT (X57-5963-01) (A/2)

Note : The components marked with a dot (•) are parts of layer 1.

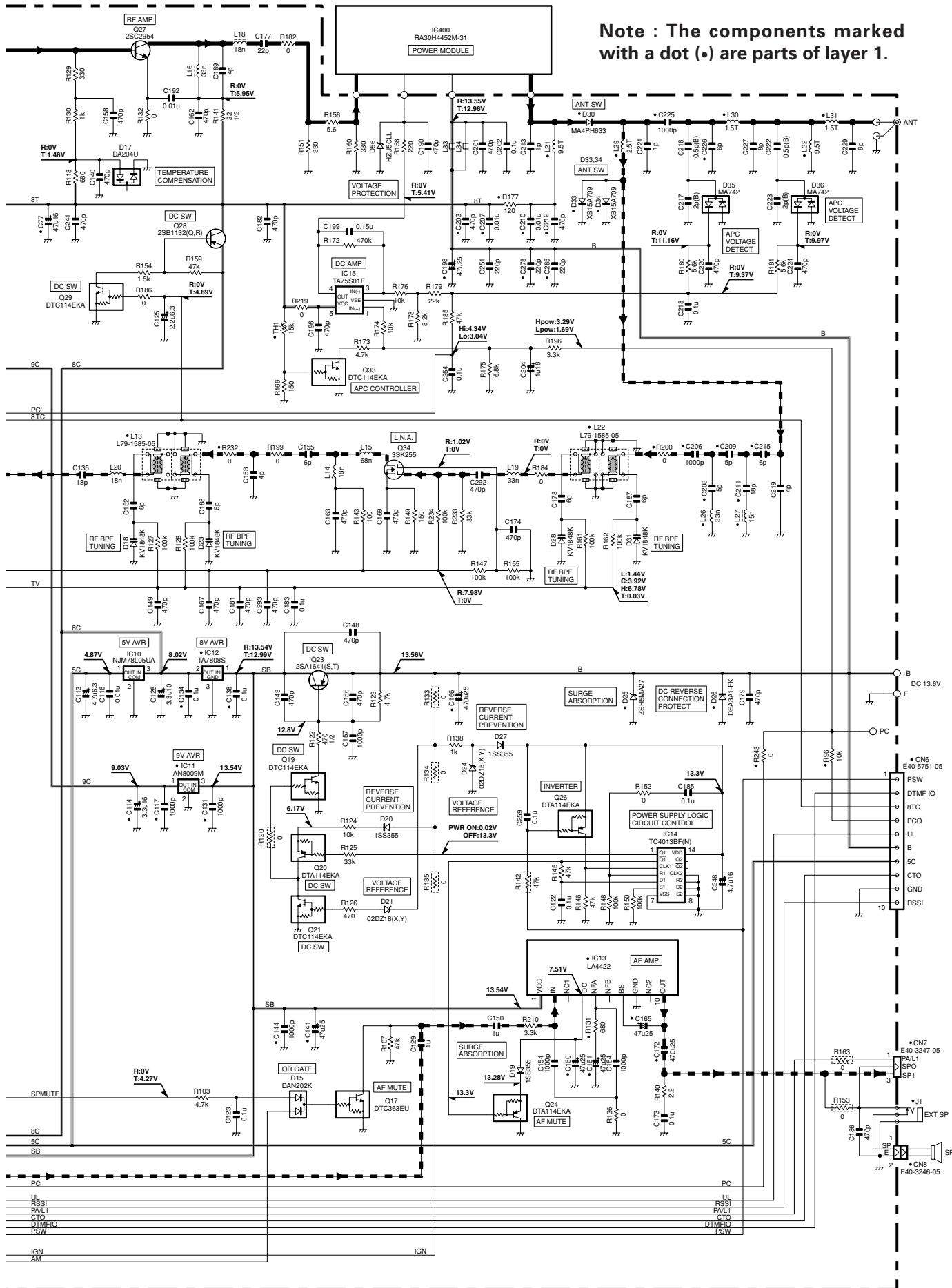

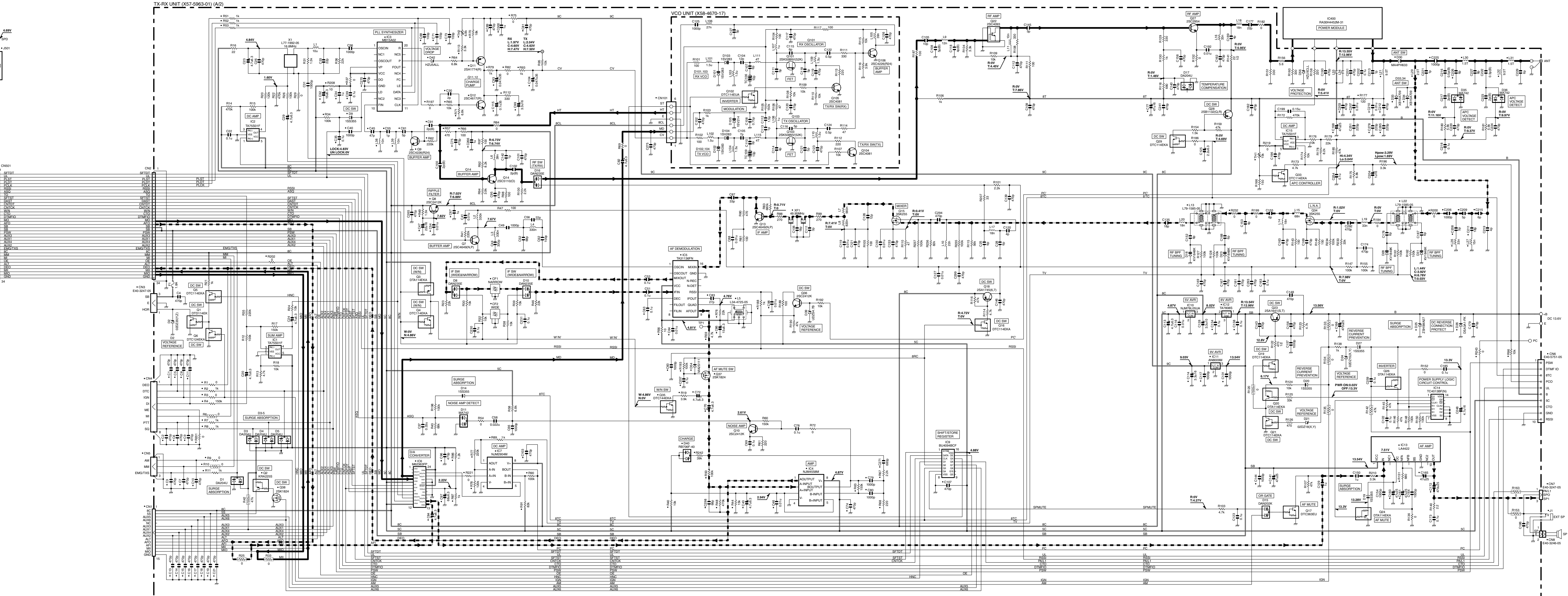
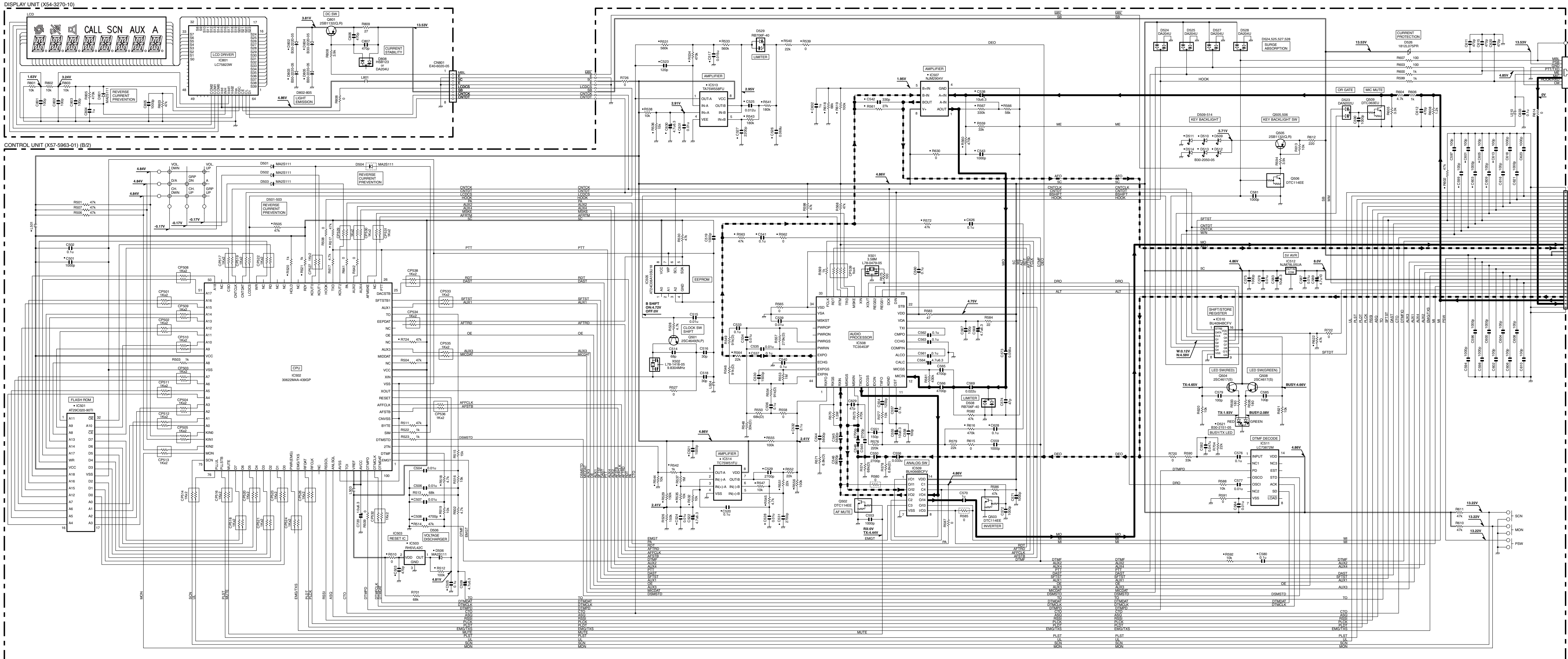

TK-868G

Kenwood Corporation

2967-3, Ishikawa-machi, Hachioji-shi, Tokyo, 192-8525 Japan

Kenwood U.S.A. Corporation

P.O. BOX 22745, 2201 East Dominguez Street, Long Beach,
CA 90801-5745, U.S.A.

Kenwood Electronics Canada Inc.

6070 Kestrel Road, Mississauga, Ontario, Canada L5T 1S8

Kenwood Electronics Deutschland GmbH

Rembrücker Str. 15, 63150 Heusenstamm, Germany

Kenwood Electronics Belgium N.V.

Leuvensesteenweg 248 J, 1800 Vilvoorde, Belgium

Kenwood Electronics France S.A.

L'Etoile Paris Nord 2, 50 Allée des Impressionnistes,
Bp 58416 Villepinte, 95944 Roissy Ch De Gaulle Cedex

Kenwood Electronics UK Limited

KENWOOD House, Dwight Road, Watford, Herts.,
WD18 9EB United Kingdom

Kenwood Electronics Europe B.V.

Amsterdamseweg 37, 1422 AC Uithoorn, The Netherlands

Kenwood Electronics Italia S.p.A.

Via G. Sirtori, 7/9 20129 Milano, Italy

Kenwood Ibérica, S.A.

Bolivia, 239-08020 Barcelona, Spain

Kenwood Electronics Australia Pty. Ltd.

(A.C.N. 001 499 074)

16 Giffnock Avenue, Centrecourt Estate, North Ryde, N.S.W. 2113 Australia

Kenwood Electronics (Hong Kong) Ltd.

Unit 3712-3724, Level 37, Tower one Metroplaza, 223 Hing Fong Road,
Kwai Fong, N.T., Hong Kong

Kenwood Electronics Singapore Pte Ltd

1 Ang Mo Kio Street 63, Singapore 569110